

ANALOGUES OF CYCLIC AMP AND THEIR PHYSIOLOGICAL RESPONSE

M. NELBOECK, G. MICHAL and G. WEIMANN

Boehringer Mannheim GmbH, Biochemica Werk Tutzing. (Germany)

R. PAOLETTI and F. BERTI

*Istituto di Farmacologia e di Farmacognosia,
Università di Milano (Italy)*

ABSTRACT

Sutherland's second messenger model and the intracellular cAMP[†]-system is presented. The key-points of its manipulation by externally applied compounds are discussed. They form the guidelines for development of chemical analogues of the cAMP molecule effective on phosphodiesterases and protein kinases.

Special attention is devoted to their influence on glycogenolysis, steroidogenesis, lipolysis, hormone secretion and contractility of various muscles. Some of these analogues show relatively high specificity of physiological responses, such as separation of metabolic and contractile effects, while others show general enhancement of the multivalent responses of cAMP itself. It is shown that a good correlation between *in vitro* and *in vivo* data exist. The pharmacological significance of these findings is briefly discussed.

† Abbreviations:

AICAR: 4-amino-imidazole-5-carboxamide riboside

ACTH: adrenocorticotropin hormone

A-5'-MP: adenosine-5'-monophosphate

ASN: adenosine

ATP: adenosine triphosphate

cAMP: adenosine-3':5'-monophosphate, cyclic AMP

cCMP: cytidine-3':5'-monophosphate, cyclic CMP

cdAMP: desoxyadenosine-3':5'-monophosphate, cyclic dAMP

cdTMP: desoxythymidine-3':5'-monophosphate, cyclic dTMP

cGMP: guanosine-3':5'-monophosphate, cyclic GMP

cIMP: inosine-3':5'-monophosphate, cyclic IMP

cTuMP: tubercidine-3':5'-monophosphate, cyclic TuMP

cUMP: uridine-3':5'-monophosphate, cyclic UMP

cXMP: xanthosine-3':5'-monophosphate, cyclic XMP

DBcAMP: N⁶,2'-O-dibutyryl-adenosine-3':5'-monophosphate

DBcGMP: N²,2'-O-dibutyryl-guanosine-3':5'-monophosphate

DG: diglyceride

FFA: free fatty acids

GTP: guanosine triphosphate

MG: monoglyceride

PDE: 3':5'-phosphodiesterase

PIA: N⁶-phenylisopropyl-adenosine

PP_i: pyrophosphate

RH: releasing hormone

TG: triglyceride

TSH: thyreostimulating hormone

THE SECOND MESSENGER MODEL

The humoral regulation of various tissue functions in mammals depends on information transmitters, usually called 'hormones'. They are generated in secretory tissues, from which they are released as a response to neural or humoral stimuli. Thus, they transfer the information to the target organ. As an example, the regulation process in the thyroid system functions as follows: humoral and neural signals stimulate a primary endocrine gland (hypothalamus), the secreted hormone (TSH releasing factor) reaches via the circulation a dependent gland (pituitary gland), where the process is repeated. The secreted hormone (TSH) finally reaches the target organ (thyroid gland), exerts its influence on the tissue and is subsequently metabolized. This decrease in hormone concentration, in turn, may be a stimulus for renewed action of the primary endocrine gland.

Sutherland and his coworkers^{1†} were the first to show that an intracellular increase of an adenosine nucleotide with a cyclic phosphate ester group (cAMP) precedes the hormone regulated events in the target tissues.

Formation and degradation of cAMP is regulated by two ubiquitous enzymes (*Figure 1*), the ATP cyclase and the 3':5'-phosphodiesterase (PDE). ATP cyclase forms an intramolecular ester-bond between the α -phosphorus of ATP and the 3'-hydroxyl group, releasing inorganic pyrophosphate. The equilibrium of the reaction does not favour cAMP formation. In some microorganisms the ATP cyclase is found in the cytoplasm, while the enzyme in cariontes occurs in membrane-bound form. When the enzyme is dissociated, for example by adding detergents, its capacity for activation by hormones is lost or drastically reduced.

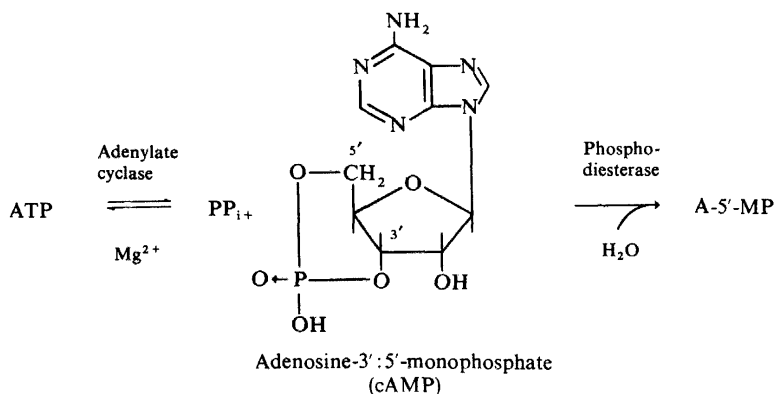

Figure 1. Formation and degradation of cAMP.

The intracellular cAMP-levels are strongly influenced by specific phosphodiesterases, which cleave the 3':5'-cyclophosphate ring, forming the corresponding nucleoside-5'-monophosphate. The enzyme, isolated from various sources, is soluble and localized to a great part in the cytoplasm.

† For comprehensive literature see the monograph of Sutherland *et al.*²

CYCLIC AMP ANALOGUES

Since the discovery of Sutherland most hormones have been found to activate the ATP cyclase and thus elevate the intracellular cAMP-level (Table 1). The hormone-regulated ATP cyclase is the centrepiece of Sutherland's second messenger concept (review by Robison *et al.*²; Figure 2) and consequently, is the key to our current understanding of hormone action. The particle-bound cyclase seems to be connected with a series of receptors, that differentiate between the various arriving hormones. One can assume, that the cell-surfaces of different tissues show different receptor patterns, and, therefore, they are stimulated by different hormones. Our present knowledge of the molecular mechanism of this hormone-induced activation

Table 1. Some hormones which influence the intracellular concentration of cyclic AMP

Prostaglandins	Adrenocorticotrophic hormone
Catecholamines	Thyroid releasing factor
Glucagon	Thyroid stimulating hormone
Vasopressin	Melanocyte stimulating hormone
Histamine	Parathyroid hormone
Serotonin	Luteotropic hormone

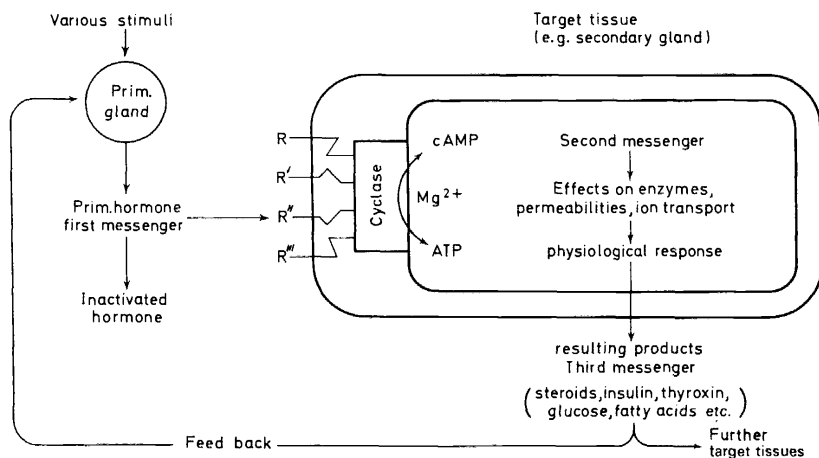

Figure 2. Second messenger model (modified according to Sutherland). The primary response to a hormonal signal is the intracellular formation of cAMP which, in turn, produces typical effects. Compounds formed this way may act as hormonal signals in the extracellular space again.

process is limited. Possibly prostaglandins are involved. The products resulting from the cellular response of the cAMP may influence both the secretory gland via a feedback mechanism, and a further target tissue, possibly by activating a cyclase again. In this chain of events the hormone is the first messenger and the cAMP the second.

It is surprising how many effects arise from the single event, cAMP elevation, such as changes in enzyme activity, in membrane potentials and in ion flux, until the effects of cAMP are neutralized by the specific PDE. A partial list of these actions is shown in *Table 2*. In liver, glycogenolysis, gluconeogenesis, urea formation and inhibition of lipid synthesis occurs, while in adipose tissue, lipolysis is stimulated. Generally speaking, in these tissues, stimulation of catabolic pathways prevails. The effects on contractile tissues as well as on hormone release will be a further subject of this paper.

In contrast to ATP, which represents the universal energy transmitter of the living cell, cAMP is, most likely, the universal intracellular information transmitter. The cAMP-concentration within the cell is about 10^{-7} M and is drastically lower than the concentration of other adenine nucleotides (e.g. ATP, ca. 10^{-3} M). cAMP apparently can cross the cell wall barrier from the intracellular to the extracellular space (but not in the reverse direction!), since cAMP is found in blood and in urine.

Table 2. Effects of cyclic AMP in several organs

	<i>Metabolic effects</i>	
Liver	Glycogenolysis	increased
	Gluconeogenesis	increased
	Urea formation	increased
	Ketogenesis	increased
	Amino acid uptake	increased
	Amino acid → protein	decreased
	Lipogenesis	decreased
	Net K ⁺ - and Ca ²⁺ -efflux	increased
Adipose tissue	Lipolysis	increased
	O ₂ -consumption	increased
Kidney	Permeability (Tubules)	increased
	Renin production	increased
Bone	Ca ²⁺ resorption	increased
Cardiac muscle	Ca ²⁺ uptake	increased
Gastric mucosa	HCl secretion	increased
	<i>Other tissue effects</i>	
Smooth muscle	Relaxation	increased
Cardiac muscle	Rate of contraction	increased
	Force of contraction	increased
	Aggregation	decreased
Platelets	Permeability	increased
Toad bladder		
Cerebellar Purkinje cells	Discharge frequency	decreased
	<i>Hormone release</i>	
Anterior pituitary	Adrenocorticotropic hormone	increased
	Thyroid stimulating hormone	increased
	Growth hormone	increased
Thyroid	Thyroid hormone	increased
	Calcitonin	increased
Pancreas Exocrine Islets	Amylase	increased
	Insulin	increased
	Corticosteroids	increased
Adrenal (Cortex)		

THE cAMP-SYSTEM

One is tempted to postulate that the multiplicity of biochemical events caused by the presence of cAMP is based on a common principle of action. Indeed, the discovery of cAMP-sensitive protein kinases in various tissues supports this assumption^{3,4}. Protein kinases phosphorylate other catalytic proteins and thus modulate their activity. In general, protein kinases consist of regulatory and catalytic subunits. Binding of cAMP to the regulatory site causes the complex to dissociate, thereby releasing the enzymatically active, catalytic subunit of the protein kinase. The physiological substrates of the various protein kinases are not yet completely known. Their identification is necessary in order to clarify the mechanism of action of the second messenger in the different tissues.

Besides regulation of vital cell processes by cAMP, there is good evidence that cGMP may play an important role, too (for a review, see Hardman *et al.*⁵). The tissue level of cGMP is lower than that of cAMP by a factor of 10 to 100. The GTP cyclase which forms cGMP from GTP is partially soluble unlike the ATP cyclase. cGMP catabolism seems to be controlled by G-specific phosphodiesterases, though each nucleotide inhibits the other's hydrolysis. cGMP appears to stimulate other protein kinases than cAMP. These facts imply that the spectrum of its biochemical effects is shifted, as compared to cAMP. The significance of the physiological occurrence of cGMP has not been ascertained so far.

The same holds true for various protein factors that seem to control the activity of phosphodiesterases and protein kinases⁶⁻⁸.

These more or less well established facts are compiled in *Figure 3*. The chain of events is started by humoral or neural input signals. By elevation of the cAMP level, enzyme activities are modulated either by direct effects or

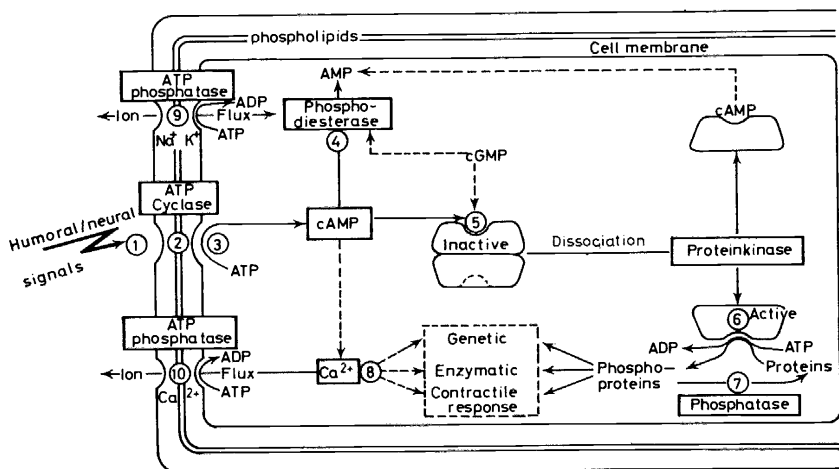

Figure 3. Keypoints of attack in the cAMP-system. The mechanism of the events from the hormonal input signal to the cellular response is shown. Solid lines indicate well established reactions, dashed lines hypothetical ones. Figures indicate points where the cAMP system may be influenced. For details see the text.

via triggering the protein synthesis. These processes alter the dynamic situation of various metabolic pathways. Other tissue effects such as relaxation of the smooth muscle or increase of the force of contraction in the cardiac muscle are controlled by cAMP, at least partly by the regulation of the ion-transport, especially of the calcium flux. Both principles may be involved in the stimulation of hormone secretion by the second messenger.

cAMP-effects depend primarily on the activities of ATP-cyclase, phosphodiesterase and protein kinase. Key positions for the modulations of the second messenger system are numbered in *Figure 3*. They are the ATP cyclase, consisting of the receptor site where the hormone signal is received (1), the phospholipid layer (2), and the catalytic site at the inner side of the plasma membrane (3), and further the phosphodiesterase (4), the regulatory site of the protein kinase (5) and subsequently its catalytic centre (6) after activation has taken place. In addition, indirect effects on the system may play an important role, e.g. phosphatases can deactivate phosphoproteins by dephosphorylation. Our present knowledge about the influence of cAMP-level on ion transport, especially on the calcium flux, is limited. Dotted lines in *Figure 3* indicate this connection. Maybe this phenomenon reflects a feed-back mechanism, caused by ATPases. These membrane-bound ATP-hydrolyzing enzymes are presumably in close association with the ATP cyclase, both acting with ATP as the same substrate, however, with different affinity constants. Numbers 7, 8, 9 and 10 in *Figure 3* show these more indirect points of attack.

Despite the fact that many details are still subject to speculation, the theoretical model explains the molecular mode of action of an ever increasing number of pharmaceutical and physiological agents. It may explain furthermore, why structurally widely different molecules may show the same or a very similar action in the same tissue. For example, lipolysis in fat pads is stimulated by cAMP. This system is blocked by a variety of compounds. The common basis for the antilipolytic effect is the decrease of cAMP level. *Figure 4* (redrawn from Butcher⁹) shows this decrease of epinephrine-stimulated cAMP levels by several antilipolytic compounds. However, the point of attack for these agents is quite different. Insulin and propranolol act on different receptors of the adenyl cyclase system. Prostaglandins influence, very likely, the mechanism in the lipid layer of the membrane. The effects of pyrazole derivatives and of nicotinic acid are not yet completely understood. With insulin, a reaction with the cell surface is sufficient for a cellular response. This has been recently demonstrated by Cuatrecasas *et al.*¹⁰. Insulin, which had been fixed covalently on a macromolecular carrier (agarose), was fully active towards an adipose tissue culture.

Table 3. Inhibitors of 3':5'-cyclic nucleotide phosphodiesterases

Methylxanthines ⁵⁶ (Theophylline, Caffeine etc.)	Phenothiazines ⁶⁰ Reserpine ⁶⁰
Pur omycin ⁵⁷	Papaverin ⁶¹
Triiodotyronine ⁵⁸	Triazolo-(4,3- α)-pyrazines ¹¹
Diazoxide ⁵⁹	Sulphonylurea agents ⁶²

CYCLIC AMP ANALOGUES

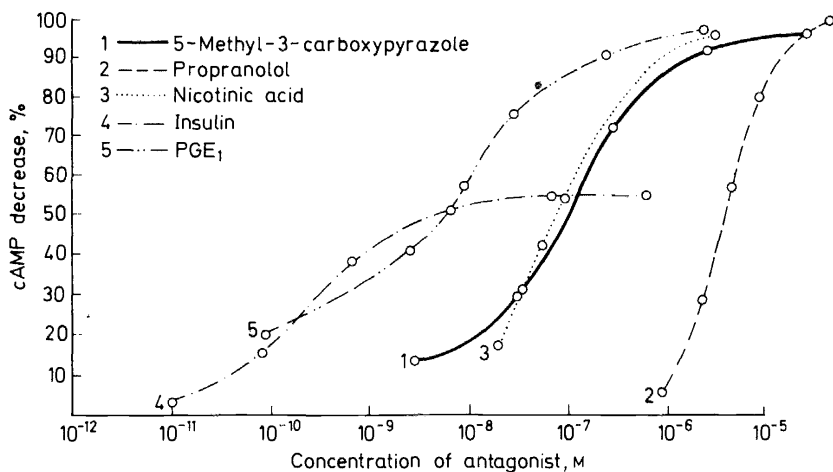

Figure 4. Decrease of cAMP levels under influence of antipolytic agents in isolated fat cells of the rat (redrawn from Butcher⁹). The term cAMP decrease, % refers to the reduction of the effect of 5.5 μM epinephrine + 1.0 mM caffeine on cAMP levels after 10 minutes incubation with the antagonist.

Inhibition of phosphodiesterases, causing elevation of the cAMP-level is at least partially responsible for the experimentally observed effects of other drugs as shown in Table 3. The action of theophylline on the cardiac muscle, of papaverine on the smooth muscle, of phenothiazines on the central nervous system and of sulphonylurea derivatives on the β -cells of the pancreas are some examples of an involvement of PDE in drug action. A good indication is an increase in cAMP following drug administration. Thus it is not surprising that the comparison of the phosphodiesterase inhibition in special tissues with the physiological response *in vivo* plays an increasing role in drug development¹¹⁻¹³.

cAMP-ANALOGUES

Drugs which show effects in the cAMP system should show principally multiple physiological responses. Since, however, those molecules frequently achieve high specificities, a tissue-specific distribution of enzymes of the cAMP-system must exist. These different enzyme patterns, on the other hand, might offer a chance to achieve a selective mode of action by chemical modification of the native second messenger. Experiments along this line are being conducted in several laboratories.

Figure 5 shows the chemical alterations of the cAMP molecule, which have been reported so far. They include the C-2, C-6 and C-8 positions at the heterocyclic moiety, the *N*-glycosidic linkage, the substitution on the 2'-hydroxyl-site of the ribose and the substitution of the oxygen in the P-O-linkages by —S— or —CH₂—. The ability of these derivatives to mimic the various effects of endogenous cAMP was checked in *in vitro* and

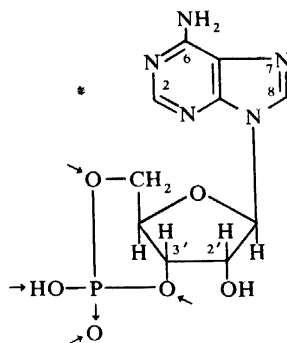

Figure 5. Synthesized derivatives of cyclic AMP. Modifications of the purine base, sugar, phosphate ring and *N*-ribosidic linkage.

in vivo systems. It could be demonstrated that chemical variation of the cAMP molecule produces remarkable changes in the biological activity profile.

This line of investigation originated from a derivative, *N*⁶,2'-*O*-dibutyryl-cAMP, which was developed by Posternak *et al.*¹⁴. Several authors have shown that the spectrum of effects of this derivative is similar to cAMP in most, but not in all systems, while the intrinsic activity—when measured in whole tissue preparations or *in vivo*—is much superior. It has been concluded that the increase in potency is due to the lipophilic character and, therefore, improved penetration properties. Moreover, this compound showed a much better resistance to enzymatic attack by phosphodiesterases. Later on it was shown, that increased activity was mainly due to the *N*⁶-monobutyryl residue, since the dibutyryl derivative loses its 2'-*O*-butyryl-residue under physiological conditions quite rapidly¹⁵.

Measurement of sensitivity to PDE is of major importance in evaluating potential usefulness of cAMP-analogues. Table 4 shows the rate of hydrolysis

Table 4. Substrate specificity of phosphodiesterase from various tissues. (Collected data from various authors.) The figures represent percentage values of the splitting rate of cAMP

	Rat	Brain Bovine	Rabbit	Heart Dog	Beef	Liver Rat
Purines						
cyclic AMP	100	100	100	100	100	100
cyclic GMP	70	20	33	33	50-100	49
cyclic IMP	—	30	—	55 65	70-120	86
cyclic XMP	—	—	—	—	15-20	—
cyclic dAMP	—	—	—	—	ca.60	—
Pyrimidines						
cyclic UMP	30	2	11	12-15	5-8	8-9
cyclic CMP	—	0	0	0	0.6	0-5
cyclic dTMP	—	0	—	—	0.4-0.6	—

CYCLIC AMP ANALOGUES

of some cyclic nucleotides by phosphodiesterases, which were isolated from a variety of species and tissues. With the exception of cUMP, the cyclic pyrimidine nucleotides are not attacked. Recently a cUMP-specific phosphodiesterase was described, but its physiological significance is unknown so far¹⁶. Based on currently available data, one may conclude that the enzymology of phosphodiesterase is very complex. This enzyme is not only found in the cytoplasm, but also in a particle bound form. Enzymes, derived from different species and from various tissues of the same species, apparently differ in many respects. Even from the same tissue, at least two forms can be identified, which differ in their molecular weight and the K_A -values for cAMP and cGMP. The rate of hydrolysis of these two substrates is influenced by their concentration ratio¹⁷.

In our laboratory, phosphodiesterase from bovine heart was investigated in more detail¹⁸. In the course of the purification of that enzyme, fractions with discernible activities towards cAMP and cGMP were isolated. In *Table 5*, they have been named PDE-A and PDE-G. We checked the enzymatic activity in these fractions with a series of analogues. The rate of hydrolysis is given in per cent values relative to cAMP hydrolysis. When cAMP derivatives were tested, the relative rates of hydrolysis with both fractions were the same. When, however, the C-6 amino group on the nucleobase was replaced by a C-6 hydroxy group, that is, when derivatives of cIMP and cGMP were subjected to incubation with PDE-A and PDE-G, pronounced differences in the relative rates of hydrolysis were observed. As can be seen from *Table 5*, the decisive factor whether a derivative behaves as an A- or as a G-type is apparently the substituent in the C-6 position of the molecule. Attachment of bulky substituents causes a decrease in the

Table 5. Splitting rates with two fractions of bovine heart PDE relative to the splitting rate of cAMP = 100 per cent¹⁸. Figures in parentheses represent the splitting rate relative to cGMP = 100 per cent. For more details see the text

Compound	Splitting rate with beef heart PDE, %	
	PDE-A	PDE-G
cAMP	100	100
cIMP	56 (104)	135 (99)
cGMP	54 (100)	136 (100)
cdAMP	59	63
cXMP	20 (37)	44 (33)
2'-O-Acetyl-cIMP	62 (114)	120 (88)
2'-O-Benzoyl-cIMP	52 (96)	109 (80)
6-Cl-purine riboside cMP	21 (40)	50 (37)
6-(3',4'-Dimethoxyphenylethyl)-cAMP	0.3 (0.55)	0.7 (0.5)
6-Dimethyl-cAMP	16.7	18.7
N ² -Benzoyl-cGMP	30 (55)	68 (50)

hydrolysis rate. Summarizing our experiments with PDE, the susceptibility to enzymatic attack depends on the chemical structure as follows (*Figure 6*). The highest resistance is observed with 8-substituted analogues, the corresponding C-6 and C-2 derivatives are less resistant¹⁹. The high biological stability of the 8-substituted cyclophosphate analogues is at least partially

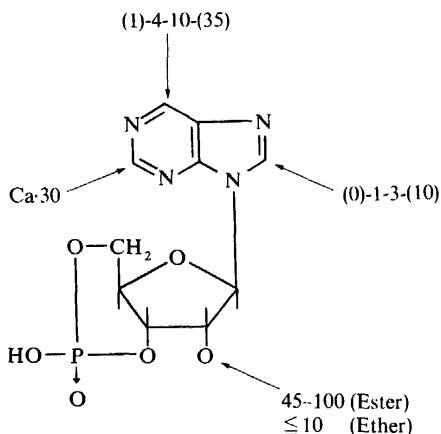

Figure 6. PDE-Splitting rates of derivatives with large substituents^{18,19}. The figures indicate percentage of the splitting rate relative to cAMP or cGMP (= 100%), provided there is a bulky substituent at the locations indicated. Figures in parentheses are extreme values, other figures represent frequent values.

caused by the restricted rotation at the *N*-glycosidic linkage (Figure 7). The so-called *syn*- and *anti*-conformations differ in the relative position of purine base to the sugar moiety. It appears that the *syn*-form is more resistant to attack by PDE. In addition, the imidazole ring of the purine moiety seems to be a prerequisite for the binding to the active site on the enzyme, in view of the resistance of pyrimidine nucleotides to enzymatic attack. Analogues modified at the C-6 and C-2 position are not restricted in rotation around the *N*-glycosidic linkage and, therefore, are split by phosphodiesterase.

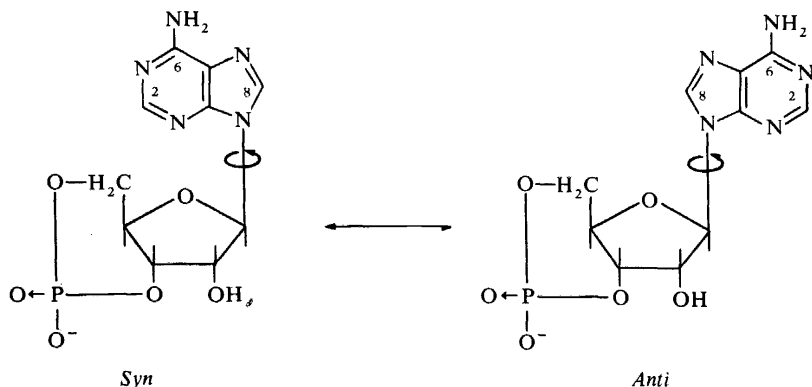

Figure 7. *Syn*- and *anti*-forms of cAMP. The conformations differ in the relative position of purine base to the sugar moiety. The *syn*-form seems to be less attacked by PDE.

CYCLIC AMP ANALOGUES

Kuo and Greengard²⁰ were the first to show that analogues of cAMP may act on protein kinases. Among other compounds, they tested the cyclic phosphate of tubercidine (an antibiotic, developed by the Upjohn Co., in which the N of position 7 is substituted by —CH=), and also the 5'- and the 3'-methylene phosphonate of cAMP, synthesized in the laboratories of the Syntex Co. (Figure 8). They used protein kinases from different tissues,

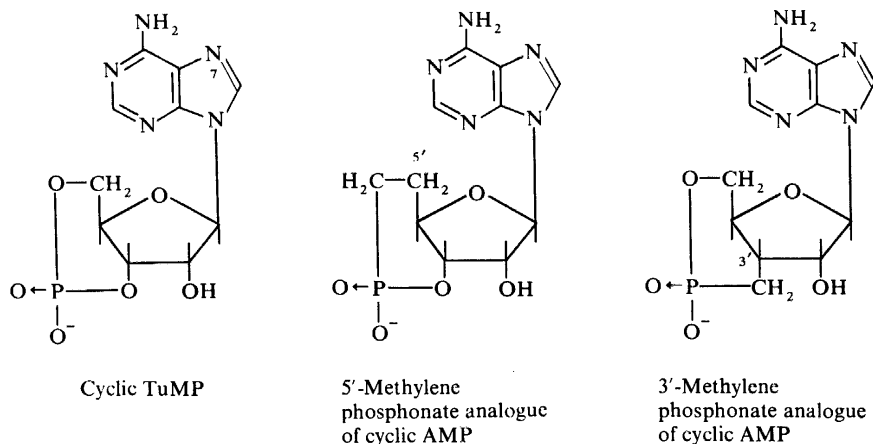

Figure 8. Structures of analogues of cyclic AMP. The compounds have been developed in the laboratories of the Upjohn Co. (cyclic TuMP) and of the Syntex Co. (methylene cyclic phosphonates).

including a cAMP-specific as well as a cGMP-specific enzyme, both from lobster muscle. The maximum of activity of these derivatives was found to be at about 10^{-6} M. Table 6 shows selected data from this paper. The tubercidine derivative stimulates all protein kinases in a similar way as cAMP

Table 6. Stimulation of cyclic AMP- and cyclic GMP-dependent protein kinases by cyclic AMP analogues (Selected data from Kuo and Greengard²⁰). Protein kinase activity was assayed by measuring the phosphorylation of histone; one unit is defined as that amount of enzyme that transfers 1 pmole of ³²P from γ -³²P-ATP to recovered protein in 5 min at 30°C

Cyclic nucleotide $5.0 \cdot 10^{-6}$ M	Enzyme source and units of activity				
	Bovine		Rat	Lobster	
	Brain	Heart	Adipose cells	Muscle cAMP-depend.	Muscle cGMP-depend.
None	8.6	30.1	9.6	13.4	12.2
Cyclic AMP	135.4	142.2	38.1	45.6	34.1
Cyclic GMP	85.9	124.3	31.8	39.8	43.7
Cyclic TuMP	131.4	141.2	38.5	43.9	42.5
5'-Methylene analogue of cyclic AMP	27.9	142.3	17.1	35.2	13.3
3'-Methylene analogue of cyclic AMP	9.0	35.1	8.7	11.7	11.7

itself. The 5'-methylene phosphonate is active on the kinase from heart muscle, whereas the cGMP-specific enzyme from lobster muscle is not affected. The cyclic 3'-methylene phosphonate is not active in these systems.

The effects of several 8-substituted cAMP derivatives on a protein kinase from bovine brain have been investigated in the Squibb Institute for Medical Research²¹. Very different effects have been found in this system, too. The data of *Table 7* represent the extreme values. Whereas the 8-methylthio-cAMP is even more effective than the second messenger, the 8-ethanol-amino-cAMP is not active.

Table 7. Activation of bovine brain protein kinase by 8-substituted cyclic AMP analogues. (Selected data from Muneyama *et al.*²¹)

Analogue	Ratio of activity* in the presence of analogue to activity in the presence of cAMP at the indicated concentration.		
	Concentration M		
	10 ⁻⁸	10 ⁻⁷	10 ⁻⁶
cAMP	1	1	1
8-SCH ₃	2.4	1.10	0.94
8-Br	0.73	0.65	0.93
8-N(CH ₃) ₂	0.43	0.56	0.91
8-NHCH ₂ C ₆ H ₅	0	0.091	0.56
8-NHCH ₂ CH ₂ OH	0	0	0

* Activity measured as pmoles of ³²P incorporated into histone.

The different behaviour of cAMP analogues towards protein kinase from different tissues is the molecular basis for the effects in more complicated metabolic processes. In the following chapters, a brief discussion of the current knowledge of cAMP-function in the different systems, the effect of analogues on enzymes in cell-free systems, on isolated tissues and finally *in vivo* is presented. For simplification, statistical data shown in the original papers have been omitted.

GLYCOGENOLYSIS

The molecular mechanisms, by which the cAMP stimulates the transformation of liver and muscle glycogen into glucose are well known due to the work of Sutherland, Krebs and of Greengard (*Figure 9*). A cAMP-dependent protein kinase activates by phosphorylation another kinase (phosphorylase kinase), which, in turn, converts the inactive phosphorylase-b into the active phosphorylase-a by phosphorylation with ATP. Simultaneously, the glycogen synthetase is inhibited by phosphorylation with the same protein kinase which initiates the glycogenolysis. The biological significance of this enzyme cascade lies in the extreme amplification of the hormonal input signal. The concentration of hormones in the blood stream is very small (about 10⁻¹¹M for peptide hormones, and somewhat higher for catecholamines). This signal of the first messenger is already amplified by

CYCLIC AMP ANALOGUES

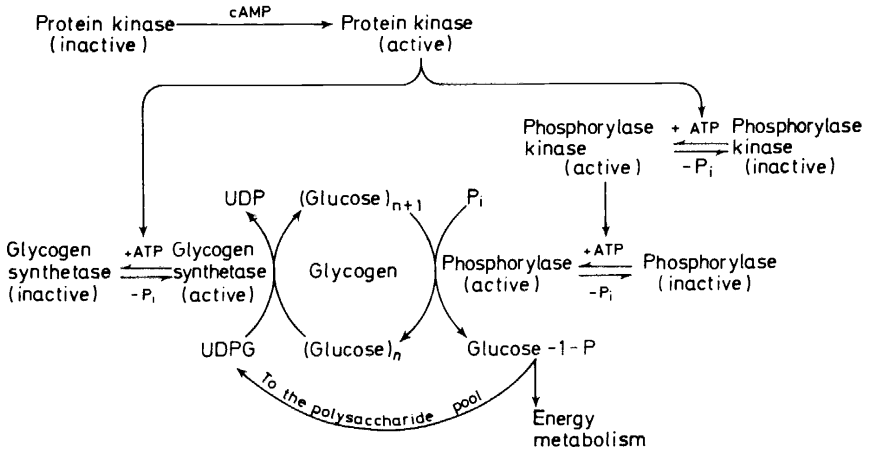

Figure 9. Cyclic AMP and glycogenolysis. The cAMP-dependent protein kinase activates by phosphorylation another kinase (phosphorylase kinase), which, in turn, converts the inactive phosphorylase into the active form. The glycogen synthetase is simultaneously inhibited by phosphorylation with the same protein kinase.

several orders of magnitude at the membrane. One can see therefore, how minimal amounts of a hormone may produce considerable conversion of metabolites.

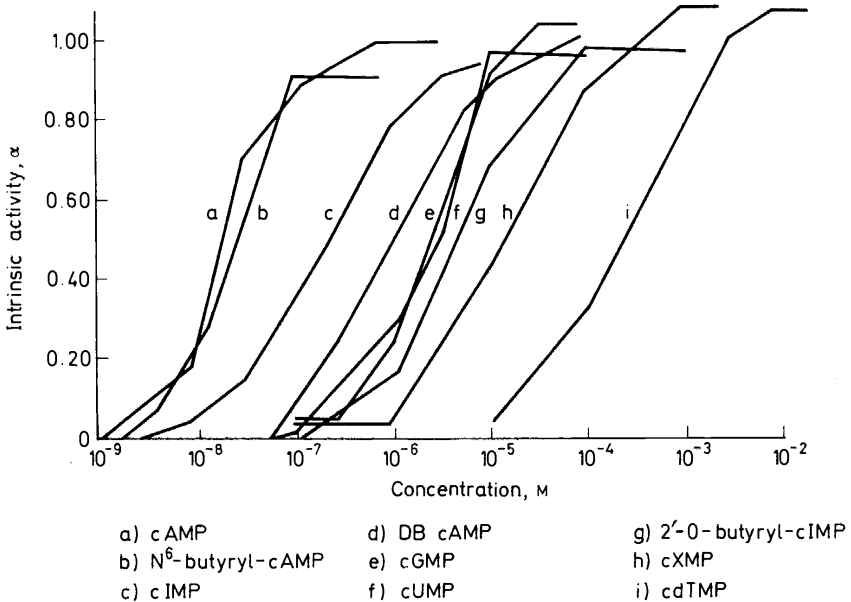

Figure 10. Glycogenolytic effects of cyclic nucleotides²². Effects were measured in the 100000 g supernatant of the liver homogenate from the rat.

In our laboratories, a large number of analogues were investigated with respect to glycogenolytic activity in supernatant from muscle or liver homogenate^{22,23} (Figure 10). Here we found a general stimulation of glycogenolysis, caused by very different concentrations. The dose responses vary by a factor of about 10^4 . In spite of this, all compounds display the same maximal activity. This structure-effect relationship is shown in Figure 11. The question, whether analogues act via inhibition of phos-

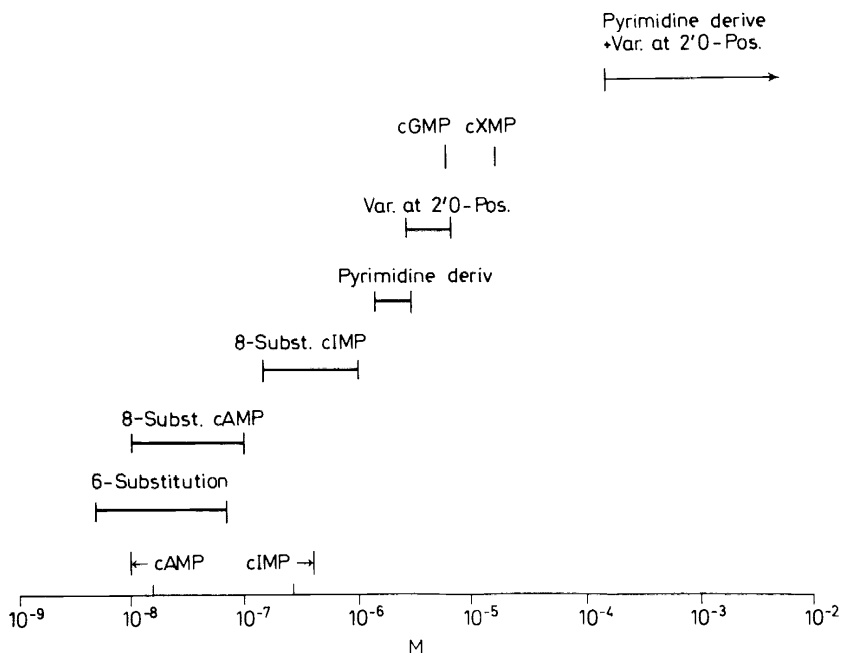

Figure 11. K_A Values of glycogenolytic activity of cyclic nucleotides in a centrifuged liver homogenate²³.

phodiesterase or via activation of protein kinase, may be answered by a comparison of the inhibitor constants of phosphodiesterase and the activation constants of glycogenolysis. As far as has been measured, the K_I -values are two to three orders of magnitude greater than the K_A -values, at least in the case of the 6-substituted analogues. Thus, the activation of glycogenolysis is determined by the protein kinase. These measurements were obtained in the liver system, but the data in skeletal muscle are almost identical. In the measurements made, the protein kinase was the rate limiting step. Contrary to the situation in other tissues, the protein kinases that activate glycogenolysis in liver and muscle appear to be similar.

Different authors investigated the glycogenolytic and gluconeogenic effects of cAMP and DBcAMP in the perfused liver of the rat and found very strong stimulation, even in intact tissue. This was especially true, when the dibutyryl derivative was used²⁴⁻²⁶.

CYCLIC AMP ANALOGUES

Paoletti *et al.*²⁷ have checked many analogues, prepared in our laboratories, for glycogenolytic effects *in vivo*. A selection of results is shown in Table 8. The figures demonstrate an increase of blood sugar 30 minutes after i.p. administration of 20 and 80 mg kg⁻¹ of the cyclic nucleotides. While the cell-free system represents the activity of the cyclic nucleotide *per se*, the *in vivo* system also depends on the penetration ability, the metabolic stability, the excretion pattern and, furthermore, on enzymatic counter-regulation. The activation constants of the *in vivo* system can be roughly estimated or extrapolated and may be correlated to the *in vitro* system. Here it can be shown that even with phosphodiesterase-resistant derivatives, a 1000-fold concentration of the *in vivo* experiments is required to obtain the same effects as those of the *in vitro* experiments. This difference appears to depend mainly on the penetration gradient^{27a}.

Table 8. Increase of blood glucose (+ mg ml⁻¹) 30 minutes after i.p. administration of cyclic nucleotides in the rat. (Selected data from Paoletti *et al.*²⁷)

Compound	Dose (mg kg ⁻¹)	
	20	80
DBcAMP	0.79	0.88
DBcGMP	0.73	1.06
2'-O-Butyryl-cIMP	0.00	0.01
N ⁶ -(3,4'-Dimethoxyphenylethyl)-cAMP	1.27	1.28
N ⁶ -(4'-Methylbenzyl)-cAMP	1.56	1.92
8-Br-cAMP	0.39	0.58
8-Br-cIMP	0.48	0.91
8-Br-cGMP	0.17	0.31
2-Benzylamino-cIMP	—	0.21
Carboxyethyl-AICAR-cMP	0.08	0.09

The spacing in Table 8 separate the various groups of analogues. The first group shows the dibutyryl derivatives as reference compounds. In the second group, the strong glycogenolytic activity of the N⁶-substituted cAMP-derivatives is striking. Interesting are the only slightly elevated values of the 8-bromo-derivatives and the lack of blood sugar elevation by 2-substituted derivatives, as shown in the last group. Most of the compounds mentioned here are resistant towards hydrolysis with phosphodiesterase.

STEROIDOGENESIS

Trophic hormones of the anterior pituitary gland stimulate steroid synthesis in the adrenal cortex and in the gonads. This procedure is mediated by cAMP. It is likely that the cyclic nucleotide stimulates the oxidation of the cholesterol side chain, thus forming pregnenolone as the common precursor of steroid hormones. The effect of the trophic hormones and of cAMP may be inhibited by puromycin, but not by actinomycin. Thus, the secretion of

steroids is preceded by a protein synthesis, which apparently is hormonally controlled at the translation step. In correlation with this, a cAMP-activated protein kinase, which phosphorylates ribosomal proteins selectively, was found in the adrenal cortex²⁸. The specificity of the receptor protein of the kinase was investigated. The results are shown in *Figure 12*. One can see the

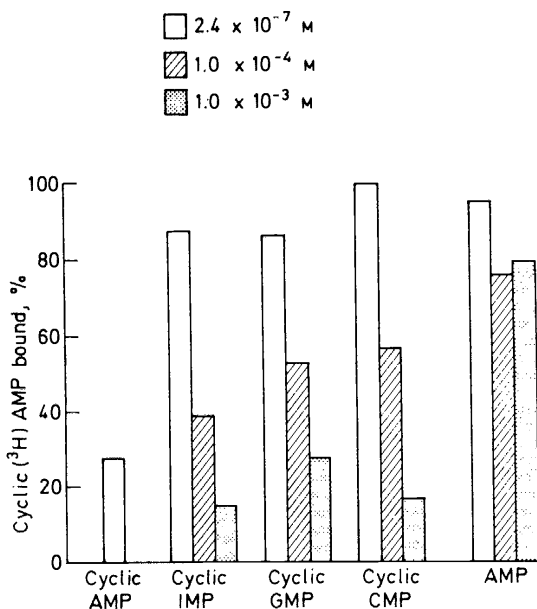

Figure 12. Effects of cyclic nucleotides on the binding of ³H-cAMP to the protein kinase from adrenal cortex²⁸. As a 100% control, binding of the ³H-cAMP without the addition of unlabelled nucleotide is used. For more details, see the text.

effects of various concentrations of cyclic nucleotides on the binding of tritiated cAMP. As a reference, the counts resulting from 100 per cent binding of ³H-cAMP are used. While (non-cyclic) AMP is almost without influence, the cyclic nucleotides of inosine and guanosine compete for the receptor site of the protein kinase, yet only with about 1 per cent of the effectiveness of cAMP.

The steroidogenic effects of these analogues have been compared with the acylated, lipophilic derivatives in slices of adrenal cortex tissue of the rat. DBcAMP was shown to be the most effective one, showing K_A -values two orders of magnitude lower than the other derivatives²⁹.

cAMP and, even more, DBcAMP have been found to stimulate not only glucocorticoids but also aldosterone synthesis³⁰. The K_A -values were compared with ACTH (*Table 9*). cGMP and DBcGMP have been found to stimulate the synthesis of glucocorticoids at 10^{-3} M without any effect on aldosterone secretion. The activation of steroidogenesis in adrenal preparations by 8-substituted derivatives of cAMP was investigated in the Squibb

CYCLIC AMP ANALOGUES

Table 9. K_A -Values for ACTH or DBcAMP as stimulators of corticosteroidogenesis³⁰. About the same concentrations of the effectors stimulate the synthesis of all three corticosteroids

	ACTH	DBcAMP
Aldosterone	$1.3 \cdot 10^{-7} \text{M}$	$1.9 \cdot 10^{-5} \text{M}$
Corticosterone	$2.4 \cdot 10^{-7} \text{M}$	$3.5 \cdot 10^{-5} \text{M}$
Cortisol	$3.5 \cdot 10^{-7} \text{M}$	$3.0 \cdot 10^{-5} \text{M}$

Institute for Medical Research³¹. Some selected data are shown in *Table 10*. The concentrations required for half-maximal secretion were compared. The 8-thiomethyl-cAMP has been shown to be the most active derivative.

Table 10. Steroidogenic response of rat adrenal cell preparations to 8-substituted derivatives of cyclic AMP³¹. The A_{50} -concentration (K_A) is defined as the concentration which stimulates a cell preparation to 50% maximum activity

Compound	Adrenal A_{50} (μM)
cAMP	3300
Dibutyl-cAMP	95
8-OH-cAMP	90
8-Br-cAMP	85
8-SCH ₃ -cAMP	65
8-SH-cAMP	380
8-NHCH ₃ -cAMP	460

Paoletti *et al.*²⁷ measured the effects of a series of derivatives, synthesized in our laboratories, in rats *in vivo*. The increase of corticosterone 30 minutes after i.p. administration of the cyclic nucleotide is given in micrograms per ml (*Table 11*). For comparison, ACTH shows a maximum increase of about $0.50 \mu\text{g ml}^{-1}$ in this system.

Table 11. Increase of blood steroids ($+\mu\text{g ml}^{-1}$) 30 minutes after i.v. administration of cyclic nucleotides in the rat. (Selected data from Paoletti *et al.*²⁷). For more details see the text

Compound	Dose (mg kg^{-1})	
	20	80
DBcAMP	0.01	0.32
DBcGMP	0.01	0.17
O-2'-Butyl-cIMP	0.09	0.24
N^6 -Benzoyl-cAMP	0.07	0.29
N^6 -(3,4-Dimethoxyphenylethyl)-cAMP	0.34	0.39
8-Br-cAMP	0.05	0.09
8-Br-cIMP	0.09	0.44
8-Br-cGMP	0.05	0.17
2-Benzylamino-cIMP	—	0.27
Carboxyethyl-AICAR-cMP	0.13	0.32

As before, the spacings separate the different groups of compounds. The first group shows butyryl derivatives of cAMP, cGMP and cIMP. Only at a high dose of 80 mg kg^{-1} does DBcAMP show a strong effect and butyryl-cIMP a moderate one. Very high activity is shown by the dimethoxyphenylethylamino-cAMP, which even induces steroidogenesis at 5 mg kg^{-1} . Activity is also exhibited by 8-bromo-cIMP, a compound neither active in cardiovascular systems nor in glycogenolysis.

Also of interest is the imidazol derivative, carboxyethyl-AICAR-cMP (bottom line), which has a pronounced steroidogenic effect. As was shown in our laboratory, these AICAR-derivatives are strongly antilipolytic, too. This will be discussed in the following section.

LIPOLYSIS

The lipolysis of the adipose tissue is assumed to be a key process of metabolism in mammalian system, just as important as glycogenolysis. It is stimulated by several hormones, triggering an enzyme cascade as shown in *Figure 13*³². The hydrolysis of the first fatty acid ester in the triglyceride

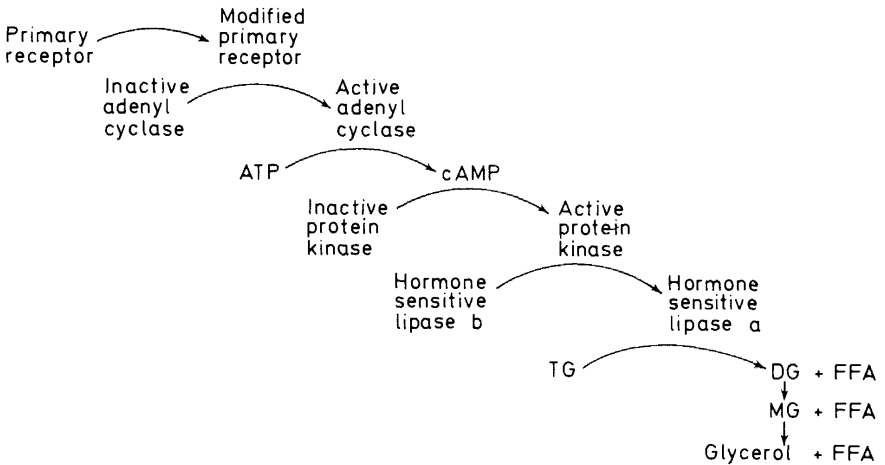

Figure 13. The lipolytic cascade³². The rate limiting step is the activation of the hormone sensitive lipase.

has been demonstrated to be the rate limiting step. It is catalyzed by a hormone-sensitive triglyceride lipase. In the laboratories of Krebs and Steinberg, the activation of this lipase by cAMP-dependent protein kinase was found^{32,33}. The understanding of the whole system is complicated by a sensitivity to several hormones, by the cooperation of several lipases and probably by a hormone antagonist, arising in the course of lipolysis³⁴ (for a review see Ref. 9).

CYCLIC AMP ANALOGUES

Blecher and coworkers³⁵ compared the lipolytic activity of several cyclic nucleotides in permeable adipocytes of the epididymal fat pad of the rat. This is shown in *Figure 14*. It is somewhat surprising that, in this system, without the barrier of a plasma membrane, the DBcAMP was found to be the most active derivative. The saturation curves prove, nevertheless, the lipolytic activity of most of the other derivatives, with the single exception of cdTMP. Lipolytic activity was also shown by the cTuMP³⁶.

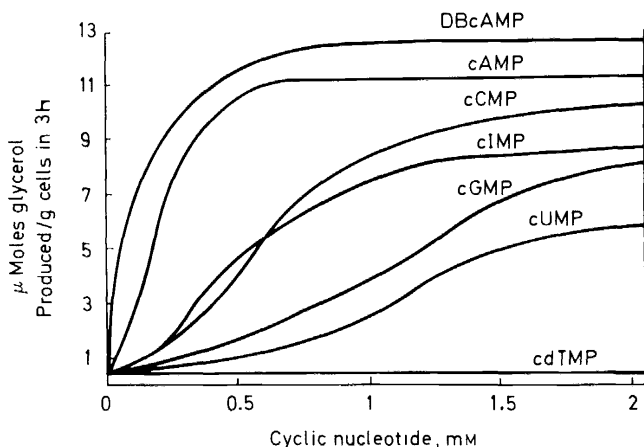
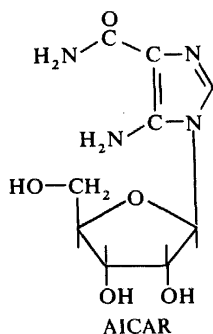

Figure 14. Lipolytic rates in permeable adipocytes as a function of the concentration of analogues of cyclic AMP³⁵. Basal lipolysis is shown by the starting point of the curves.

The effects of several 6-, 8- and 2'-substituted derivatives have been investigated both in the Squibb Institute for Medical Research³¹ and in our laboratories. The 8-thiomethyl-cAMP, the 8-benzylamino-cAMP and the 8-benzylamino-cIMP have been found to be the most active lipolytic derivatives in the permeable adipocyte system. The effect of the DBcAMP was not surpassed in any case.

An interesting behaviour in the lipolytic system has been found with ribotides of the 5-amino-imidazole-4-carboxamide (AICAR). Its cyclic phosphate and, even more, its 5'-monophosphate have a strong antilipolytic activity, both in the cell-free system and in the isolated adipocyte, as shown in *Figure 15*. This is contrary to the effects of most of the other cyclic nucleotides. AICAR itself is without any effect in this system³⁷.

There are, nevertheless, derivatives of adenosine, which are strongly antilipolytic, e.g. the *N*⁶-isopropyl-ASN (PIA), studied by Dietmann *et al.*³⁸. It acts very likely via an inhibition of the cyclase, as was shown by Westermann *et al.*³⁹. In *Figure 16*⁹ is shown the dramatic decrease of the intracellular cAMP-level after treatment of rat adipocytes with PIA, the lipolysis being prestimulated by hormones. AICAR-derivatives seem to affect (at least partially) the protein kinase³⁷.



	M	AICAR-3':5'-MP	AICAR-5'-MP	AICAR
Depression of DBcAMP stimulated lipolysis (cell-free system)	5.10^{-8}	-4%		
	1.10^{-7}		-4%	-4%
	1.10^{-6}		-100%	-2%
	5.10^{-6}	-43%		
	1.10^{-5}		-100%	-3%
	5.10^{-5}	-43%		

Figure 15. Antilipolytic effects of AICAR-derivatives in adipocytes and in the cell-free systems from fat-pads of the rat (selected data from Michal *et al.*³⁷).

It is noteworthy, that neither cAMP nor most of its derivatives which have been measured so far, showed any lipolytic activity *in vivo*. On the contrary, there was a slight antilipolytic response of DBcAMP⁴⁰. The reason for this may be a counter-regulation, but nevertheless, its mechanism is not yet understood.

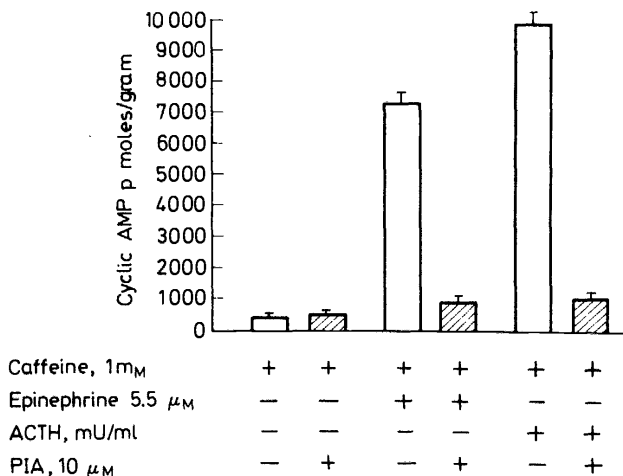

Figure 16. Effects of PIA on cyclic AMP levels in fat cells incubated with epinephrine or ACTH⁹. PIA lowers cAMP levels in fat cells at concentrations as low as 0.1 micromolar. No effects have been observed with broken cell preparations.

SECRETION OF PITUITARY HORMONES

The secretion of the hormones of the pituitary gland is probably regulated by factors released from the hypothalamus. Releasing factors for pituitary hormones have been purified from hypothalamus extracts. They enter the pituitary gland via a portal system and activate cyclases in specific areas of the anterior lobe. As was shown by Labrie *et al.*⁴¹, cAMP stimulates the hormone secretion as well as the protein synthesis in pituitary tissue.

The substrates of a cAMP-dependent protein kinase (purified from pituitary anterior lobe) were found in the rough microsomes, in the secretory granules and in the plasma membrane. These effects are summarized in the scheme proposed by Labrie *et al.*⁴¹ (Figure 17).

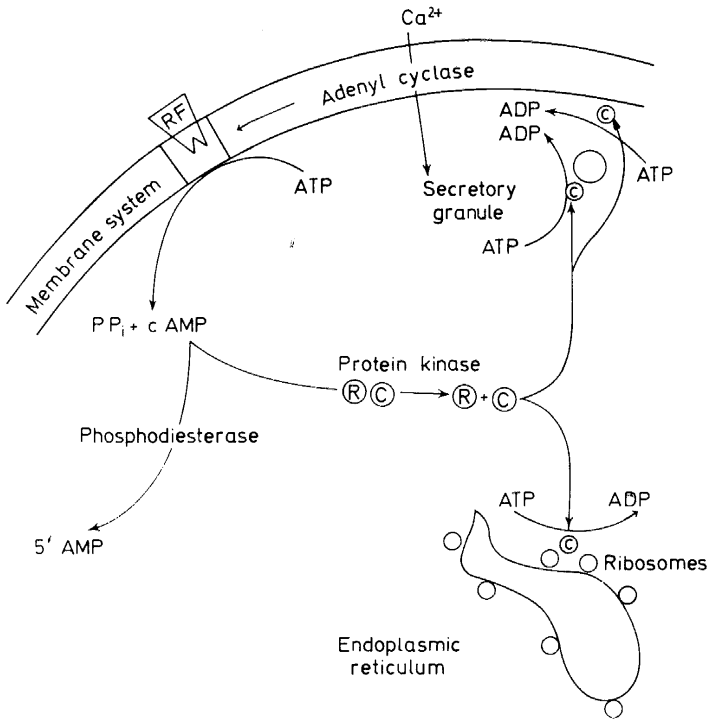

Figure 17. Cyclic AMP response in the anterior lobe of pituitary gland⁴¹.

Very likely, there are similar effects of cAMP in other secretory glands, too. The Michaelis constants of the protein kinases have been found to be about $2.5 \times 10^{-8} \text{M}$. Concentrations of 10^{-4}M of cAMP or some 8-substituted analogues are inhibitory, very likely due to a competition with ATP at the catalytic subunit of the enzyme⁴².

The stimulating effect of some 6-, 8- and 2-substituted derivatives of cAMP on secretion of thyroid stimulating hormone and of growth hormone

has been investigated by Posternak and Cehovic⁴³. The authors used slices of anterior pituitary gland of rats. A manifold increase of the effect of the second messenger has been achieved with some of these derivatives, especially with the *N*⁶,2'-*O*-dibutyl-8-thio-cAMP. This effect exceeds greatly even the effect of DBcAMP (Figure 18).

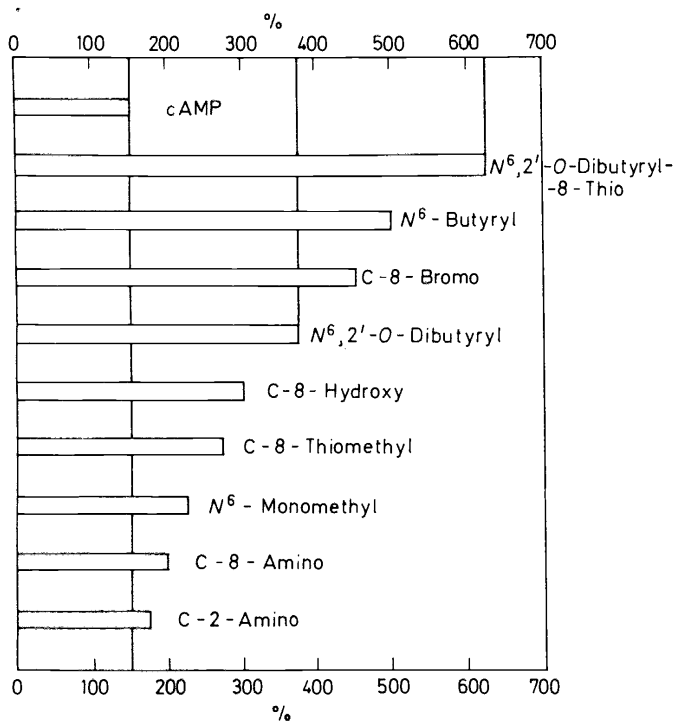

Figure 18. Action of 6-, 8-, and/or C-2-substituted derivatives of cyclic AMP on the release of GH from the anterior lobe of pituitary gland of rats (selected data from Posternak and Cehovic⁴³).

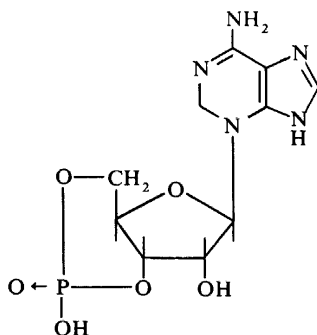

Figure 19. Iso-cyclic AMP⁴⁴.

Another interesting derivative which was synthesized and investigated by the same authors was the iso-cAMP, shown in *Figure 19* (Cehovic⁴⁴). Here, the ribotide moiety is shifted from the imidazole to the pyrimidine moiety of the purine molecule. Whereas this compound strongly stimulates the secretion of TSH, it is much less effective in stimulating growth hormone release⁴³.

EFFECTS OF cAMP-ANALOGUES ON CONTRACTILE TISSUES

The involvement of cAMP in the contraction of vascular smooth muscle of the trachea, ileum, and uterus, has been thoroughly investigated. Although the mechanism is not yet fully understood, the vasoconstrictive response on α -adrenergic stimulation is assumed to be related to a decrease, the vasodilatory response on β -adrenergic stimulation to an increase of the intracellular cAMP level⁴⁵. Because of the large differences of the relative activities of cyclase and phosphodiesterase between the centre and the periphery of the vascular system and because of the different response of the cAMP-system in the various layers of the vascular wall, it is difficult to give a unifying interpretation of drug effects on this system⁴⁶.

The perfused, isolated artery of the rat responds to a periarterial electrical stimulation (e.g. catecholamine release) with contractions. The same effect is achieved by drugs, stimulating the vascular tone (ergotamine, imidazole). In this system Berti *et al.*⁴⁷ showed a strong relaxation after DBcAMP, whereas cAMP itself has a small, but significant contractive effect. As is shown in *Figure 20*, the 8-bromo-cGMP has a strong relaxing effect on caudal artery which antagonizes both the electrical stimulation and the basal tone⁴⁸.

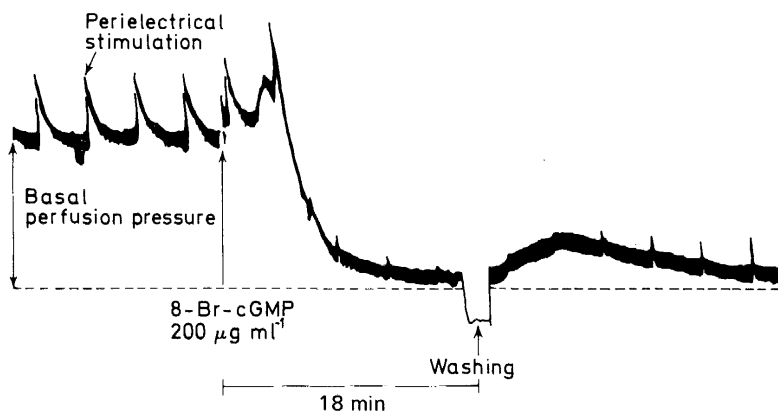

Figure 20. Smooth muscle-relaxing activity of 8-Br-cyclic GMP on the caudal artery of rats⁴⁷. The relaxing activity abolishes both the perielectrical stimulation and the basal perfusion pressure.

The GTP-cyclase is most active in the lung (rats), where the activity is tenfold higher than in other tissues^{49,50}. There may be a special function of cGMP in lung tissue, probably connected to the phosphodiesterase system. This was shown by several authors^{51,52}. Szaduykis-Szadurski *et al.*⁵³ investigated the effect of several analogues of cAMP and cGMP on the smooth muscle of the isolated trachea of guinea pig. In this system too, 8-bromo-cGMP was the most active derivative. A comparison of the effects of 8-bromo-cGMP, DBcAMP and DBcGMP is shown in *Figure 21* (redrawn

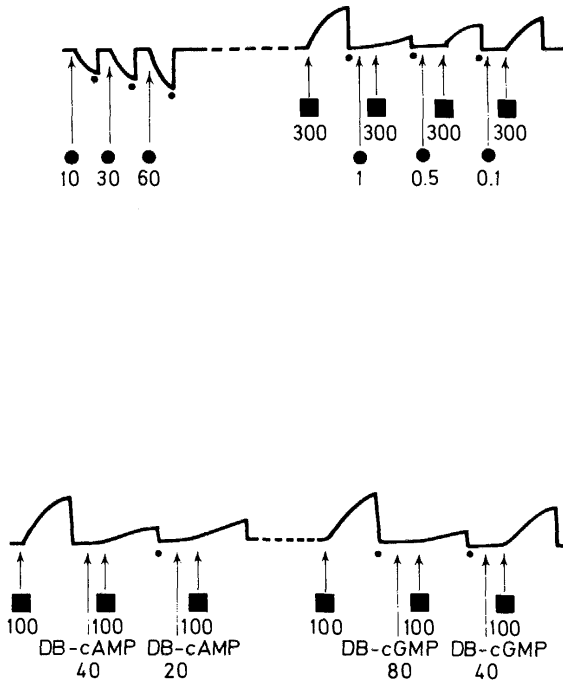

Figure 21. Effect of 8-Br-cGMP (●) on basal tone (left) and on the contraction effect of imidazole ■ (right) of tracheal smooth muscle from guinea pig (upper graph) compared with the effect of DBcAMP and DBcGMP (lower graph)⁴⁸. Numbers represent the final concentration of the drugs in $\mu\text{g ml}^{-1}$.

from Szaduykis-Szadurski and Berti⁴⁸). The upper left graph shows the dose-dependent smooth muscle relaxing effect of 8-bromo-cGMP. The upper right graph demonstrates the effect on imidazole-contracted muscle, which is antagonized by the cGMP derivative. The lower graph shows the corresponding effects of the dibutyryl derivatives, which antagonize imidazole only at 20-fold to 80-fold higher concentrations than 8-bromo-cGMP. Berti⁵⁴ demonstrated in *in vivo*-experiments that 8-bromo-cGMP relaxed histamine-induced bronchospasms in the guinea pig twice as effectively as theophylline. It should be emphasized that neither 8-bromo-GMP nor 8-bromo-guanosine showed any effect in either of these systems.

CYCLIC AMP ANALOGUES

At the Squibb Institute for Medical Research, several 8-substituted cAMP-derivatives were compared with theophylline in a similar tracheal system⁵⁵. Selected data are shown in *Table 12*. The most effective compound was 8-benzylthio-cAMP, being almost 10 times more active than DBcAMP. The 8-bromo-cAMP was almost as active as DBcAMP. Similar data were obtained with the portal vein of the rat. None of these derivatives, however, reached the response of theophylline (which was surpassed, as shown above, by 8-bromo-cGMP). This compound, therefore, reveals a pronounced relaxing activity on the vascular smooth muscle.

Table 12. Relaxant concentrations *in vitro* of theophylline and analogues of cyclic AMP on guinea pig trachea. (Selected data from Rubin *et al.*⁵⁵). IC₅₀ = average concentration ($\mu\text{g ml}^{-1}$) producing 50% relaxation of control response

Compound	IC ₅₀ ($\mu\text{g ml}^{-1}$) 10 min
Theophylline	4.4 \pm 0.4
DBcAMP	247 \pm 13
8-SCH ₂ -C ₆ H ₅ -cAMP	23 \pm 2
8-SCH ₃ -cAMP	93 \pm 7
8-N(CH ₃) ₂ -cAMP	224 \pm 33
8-Br-cAMP	236 \pm 67

Finally, let us consider the cardiovascular response. The effects of epinephrine and glucagon (the positive inotropic effect on heart muscle and coronary vasodilatation) are accompanied by an elevation of the cAMP level, although the exact mechanism is still under discussion. The response in muscle seems to be closely connected with the mobilization of intracellular pools of calcium. A further system of cyclases, bound to subcellular particles,

Table 13. Effect of analogues of cAMP on blood pressure and heart rate (anaesthetised rats, 20 mg kg⁻¹, i.v.). (Selected data from Paoletti *et al.*²⁷)

Compound	Blood pressure (mmHg)			Heart rate (min ⁻¹)		
	0'	3'	36'	0'	3'	36'
DBcAMP	106	80	95	394	330	300
DBcGMP	110	110	115	420	420	420
N ⁶ -(3,4-Dimethoxyphenylethyl)-cAMP	115	38	38	405	120	90
N ⁶ -(4-Methylbenzyl)-cAMP	102	68	75	420	428	322
8-Benzylamino-cAMP	88	83	80	330	320	310
8-Methylmercapto-cAMP	108	97	96	366	402	354
8-(4-Methylbenzylamino)-cAMP	115	115	103	440	430	380
8-Br-cGMP	95	70	80	360	360	360
2-Benzylamino-cAMP	93	91	86	335	357	323
Carboxyethyl-AICAR-cAMP	90	87	88	340	330	310

is included in the discussion of the mechanism as well as the effect of another second messenger.

In view of this not yet well understood mechanism of contractile response to cAMP, the measurements of blood pressure and heart rate should be understood phenomenologically only. *Table 13* shows the results obtained with anaesthetised rats²⁷.

One may correlate the data with those of DBcAMP and DBcGMP, shown in the first group. There is a strong response to compounds with an aralkylgroup in the *N*⁶-position, such as *N*⁶-dimethoxyphenylethyl-cAMP. Similar substituents in the 8-position of cAMP (third group) have no effect. As mentioned above, some of these 8-substituted derivatives (e.g. 8-methylmercapto- and 8-benzylamino-cAMP) have strong metabolic effects in other tissues. Substituents attached to the cIMP or cGMP moieties at the 8- and 2-positions do not cause effects on blood pressure and heart rate, although some of these compounds have steroidogenic effects, while the 8-bromo-cGMP relaxes the vascular smooth muscle, as was shown before.

PHARMACOLOGICAL ASPECTS

Do those findings have any significance for the development of new drugs? Considering the different patterns of the physiological response and the rather high specificity of the effects seen with some of these cAMP-derivatives, one may be optimistic. As we have seen, this specificity distinguishes steroidogenesis, antilipolysis, hormone secretion, the relaxation of vascular smooth muscle, etc. It seems possible to obtain compounds exerting metabolic effects quite free from vasodilatory action. Also, compounds showing effects on the tracheal smooth muscle without affecting the cardiovascular system can be selected. Finally, we have seen that the multivalent response of the second messenger—without higher specificity—is much enhanced in some analogues, e.g. DBcAMP.

As was found by Levine *et al.*, some of the effects of DBcAMP can also be reproduced in humans. The chance of such a multivalent derivative being used as a therapeutic agent depends on whether one can demonstrate that a pathological deficiency is due to a disturbance of the first messenger system. Since our knowledge of pathogenesis is not developed so far, it is too early to prove this point. Compounds with more specific effects appear easier to put to work. Moreover, for the time being, second messenger analogues seem to be a useful tool in the elucidation of basic biochemical mechanisms. This may lead to a better understanding of molecular events in drug effects. In the future, we hope that medicine, as well as biochemistry, will be able to describe normal and pathological behaviour of cellular systems in the common language of molecular biology.

REFERENCES

- ¹ E. W. Sutherland and T. W. Rall, *Pharmacol. Rev.* **12**, 265 (1960).
- ² G. A. Robison, R. W. Butcher and E. W. Sutherland, *Cyclic AMP*, Acad. Press, New York and London (1971).
- ³ J. F. Kuo and P. Greengard, *Proc. Nat. Acad. Sci. U.S.* **64**, 1349 (1969).

CYCLIC AMP ANALOGUES

- 4 P. Greengard, *Annal. New York Acad. Sci.* **185**, 18 (1971).
- 5 J. G. Hardman, J. A. Beavo, J. P. Gray, T. D. Carisman, W. D. Patterson and E. W. Sutherland, *Annal. New York Acad. Sci.* **185**, 27 (1971).
- 6 W. Y. Cheung, *Biochim. Biophys. Res. Commun.* **38**, 533 (1970).
- 7 C. D. Asby and D. A. Walsh, *Feder. Proc.* **31**, 439, Abstr. nr. 1250 (1972).
- 8 T. E. Donnelly Jr., J. F. Kuo, E. Miyamoto and P. Greengard, *Feder. Proc.* **31**, 439, Abstr. nr. 1254 (1972).
- 9 R. W. Butcher, *Arch. Pharmakol.* **269**, 358 (1971).
- 10 P. Cuatrecasas, *Proc. Nat. Acad. Sci. U.S.* **63**, 450 (1969).
- 11 A. R. Summerville, M. L. Rabouhans and A. A. Smith, *Biochem. J.* **120**, 11 P (1970).
- 12 H. Sheppard and G. Wiggan, *Molec. Pharmacology* **7**, 111 (1971).
- 13 B. Beer, M. Chasin, D. E. Clody, J. R. Vogel and Z. P. Horovitz, *Adv. Cycl. Nucl. Res.* **1**, 566. Raven Press, New York (1972).
- 14 T. Posternak, E. W. Sutherland and W. F. Henion, *Biochim. Biophys. Acta* **65**, 558 (1962).
- 15 N. I. Swislocki, *Analyt. Biochem.* **38**, 260 (1970).
- 16 U. Klotz and K. Stock, *Arch. Pharmakol. Exp. Pathol.* **269**, 117 (1971).
- 17 G. I. Drummond and M. Yamamoto in P. Boyer, *The Enzymes*, Vol. IV, 3rd ed., p. 596. Academic Press, New York and London (1971).
- 18 G. Michal, G. Weimann, M. Nelboeck and C. Thiessen (1973). In preparation.
- 19 G. Michal, M. Nelboeck and G. Weimann, *Z. Anal. Chem.* **252**, 189 (1970).
- 20 J. F. Kuo and P. Greengard, *Biochem. Biophys. Res. Commun.* **40**, 1032 (1970).
- 21 K. Muneyama, R. J. Bauer, D. A. Shuman, R. K. Robins and L. N. Simon, *Biochemistry* **10** 2390 (1971).
- 22 M. DuPlooy, G. Michal, G. Weimann, M. Nelboeck and R. Paoletti, *Biochim. Biophys. Acta* **230**, 30 (1971).
- 23 G. Michal, M. DuPlooy, M. Woschee, M. Nelboeck and G. Weimann, *Z. Anal. Chem.* **252**, 183 (1970).
- 24 L. Menahan and O. Wicland, *Biochem. Biophys. Res. Commun.* **29**, 880 (1967).
- 25 J. H. Exton and C. R. Park, *J. Biol. Chem.* **243**, 4189 (1968).
- 26 R. A. Levine and S. E. Lewis, *Biochem. Pharmacol.* **18**, 15 (1969).
- 27 R. Paoletti, F. Berti, P. F. Spano, G. Michal, G. Weimann and M. Nelboeck, *Pharm. Res. Commun.* (1972). In press.
- 27^a G. Michal, *Pharm. Res. Commun.* (1972). In press.
- 28 L. D. Garren, G. N. Gill and G. M. Walton, *Ann. New York Acad. Sci.* **185**, 210 (1971).
- 29 P. Bieck, H. Vapaatalo and E. Westermann, *Acta Physiol. Scand.* **80**, nr. 4, 28 A (1970).
- 30 H. Erbler, *Arch. Pharmakol. Exp. Pathol.* **270**, Suppl. 1, R 26 (1971).
- 31 A. C. Free, M. Chasin, V. S. Paik and S. M. Hess, *Biochemistry* **10**, 3785 (1971).
- 32 D. Steinberg and I. K. Huttunen, *Adv. Cycl. Nucl. Res.* **1**, 47. Raven Press: New York (1972).
- 33 I. D. Corbin and E. G. Krebs, *Biochem. Biophys. Res. Commun.* **36**, 328 (1969).
- 34 R. J. Ho and E. W. Sutherland, *J. Biol. Chem.* **246**, 6822 (1971).
- 35 M. Blecher, J. T. Ro'ane and P. D. Flynn, *Arch. Biochem. Biophys.* **142**, 351 (1971).
- 36 M. Blecher, J. T. Ro'ane and P. D. Flynn, *Biochem. Pharmacol.* **20**, 249 (1971).
- 37 G. Michal and G. Jurz, *Pharm. Res. Commun.* (1973). In press.
- 38 K. Dietmann, W. Schaumann, F. H. Schmidt and H. Stork, Lecture at the 3rd Intern. Symposium on Drugs Affecting Lipid Metabolism, Milan (1968).
- 39 E. Westermann, K. Stock and P. Bieck, *Fettstoffwechsel* **5**, 68 (1969).
- 40 P. Bieck, K. Stock and E. Westermann, *Life Sci.* **7**, 1125 (1968).
- 41 F. Labrie, G. Pelletier, A. Lemay, S. Lemaire, G. Poirier, N. Barden, G. Beraud, R. Boucher, M. Gauthier and A. DeLean, *Acta Physiol. Hungar.* In press.
- 42 S. Lemaire, F. Labrie and M. Gauthier, *J. Biol. Chem.* In press.
- 43 T. Posternak and G. Cehovic, *Annal. New York Acad. Sci.* **185**, 42 (1971).
- 44 G. Cehovic, *Compt. Rend. Acad. Sci. Paris, Série D*, 2929 (1969).
- 45 E. W. Sutherland, G. A. Robison and R. W. Butcher, *Circulation* **37**, 279 (1968).
- 46 L. Triner, Y. Vulliemoz, M. Verosky and G. G. Nahos, *Cardiovasc. Res.* **310**, VI. World Congr. Cardiol., Abstr. T (1970).
- 47 F. Berti, V. Bermareggi and V. Mandelli, *Arch. Intern. Pharmacodyn.* **192**, 247 (1971).
- 48 L. Szadukis-Szadurski and F. Berti, *Pharmacol. Res. Commun.* **4**, 53 (1972).
- 49 J. G. Hardman and E. W. Sutherland, *J. Biol. Chem.* **244**, 6363 (1969).
- 50 A. A. White and G. D. Aurbach, *Biochim. Biophys. Acta* **191**, 686 (1969).

- ⁵¹ F. Murad, V. Manganiello and M. Vaughan, *J. Biol. Chem.* **245**, 3352 (1970).
⁵² J. A. Beavo, J. G. Hardman and E. W. Sutherland, *J. Biol. Chem.* **245**, 5649 (1970).
⁵³ L. Szadukis-Szadurski, G. Weimann and F. Berti, *Pharmacol. Res. Commun.* **4**, 63 (1972).
⁵⁴ F. Berti (1972). (Unpublished).
⁵⁵ B. Rubin, E. H. O'Keefe, M. H. Waugh, D. G. Kotler, D. A. DeMaio and Z. P. Horovitz, *Proc. Soc. Exper. Biol. Med.* **137**, 1244 (1971).
⁵⁶ R. W. Butcher and E. W. Sutherland, *J. Biol. Chem.* **237**, 1244 (1962).
⁵⁷ M. M. Appleman and R. G. Kemp, *Biochem. Biophys. Res. Commun.* **28**, 564 (1966).
⁵⁸ L. R. Mandel and F. A. Kuehl, *Biochem. Biophys. Res. Commun.* **28**, 13 (1967).
⁵⁹ G. Senft, K. Munske, G. Schultz and M. Hoffmann, *Arch. Pharmakol. Exp. Pathol.* **259**, 344 (1968).
⁶⁰ F. Honda and H. Imamura, *Biochim. Biophys. Acta* **161**, 267 (1968).
⁶¹ W. R. Kukovetz and G. Poech, *Arch. Pharmakol. Exp. Pathol.* **267**, 189 (1970).
⁶² G. Brooker and M. Fichman, *Biochem. Biophys. Res. Commun.* **42**, 824 (1971).