

## SOME NOVEL DIAGNOSTIC TECHNIQUES FOR PLASMA CHEMISTRY

M. KAUFMAN

Department of Chemistry, Emory University, Atlanta, GA 30322, USA

**Abstract**—In order to probe the mechanisms of chemical transformations in electric discharges it is most useful to monitor concentrations of reactants, products and reactive intermediates as a function of discharge parameters. Mass spectrometry, a popular technique for observing intermediates in chemical reactions, meets with particular difficulty when applied to discharges, due to the presence of excited molecules as well as free radicals in such systems. Molecular beam analysis, a synthesis of mass spectrometry with molecular beam measurements of electric and magnetic moments and velocity distributions, is a technique developed in our laboratory which offers distinct advantages for the analysis of intermediates in electric discharges.

In low pressure discharges, end-product analysis can be facilitated by sample compression. A chromatographic sampling system which employs compression in order to achieve high sensitivity has been developed and evaluated.

There is some question concerning the appropriate discharge parameters to be employed in correlating measured variations in concentrations. We are investigating the use of discharge "actinometers" as a means of measuring the intensity of electric discharges. In discharges the intensity (number and energy of the electrons) and the chemistry are strongly coupled. Thus, it is necessary that the actinometer be present in the reactor; it is not permissible to substitute vessels as is customary in photochemical investigations. Since the actinometer is to measure only the discharge intensity, it must not participate in any chemical reactions with molecules and intermediates in the discharge. Finally, the ratio of the rates of the primary interactions of the actinometer and reactant with the discharge must be independent of discharge parameters.

### INTRODUCTION

It is generally accepted in chemistry that it is not possible to prove that a reaction proceeds by a particular mechanism; one can only eliminate unimportant pathways from consideration. Nevertheless, for many transformations, the chemical evidence and theoretical limitations supporting a particular mechanism are so overwhelming, that its acceptance is universal. In plasma chemistry much has been written concerning mechanisms and yet very few mechanisms are well established. This situation results both from the inability of simple theoretical considerations to rule out all but a few pathways, as well as from the myriad of products produced in many experimental investigations. Yet there are cases in which the yield of a single product approaches unity in the plasma reaction of a large organic molecule,<sup>2</sup> indicating that there are predominant mechanisms in discharge chemistry.

One of the most important tools used in investigating the mechanism of a chemical reaction is a study of its kinetics. For a plasma reaction the goal of a kinetics investigation is to predict the yield of various products as a function of chemical parameters (concentration, pressure and flow rate) and discharge parameters (e.g. voltage, current, frequency and reactor dimensions). The analysis is simplified in the limit of short contact times or very weak discharges, where the probability of subsequent transformations of the initial products can be ignored. It may be necessary to consider both the discharge and post-discharge environments. Alternatively, the discharge region can be sampled directly, using a technique which permits the concentration of intermediates to be measured, thereby removing one stage of speculation from the analysis. The most powerful approach combines measurements of both product yields and intermediate concentrations, demonstrating the extent to which the observed intermediates can quantitatively account for the formation of the final products by the postulated mechanism.

The successful accomplishment of such a program for any but the simplest plasma systems has not yet been reported. However, the present paper will focus on novel diagnostic techniques being developed in our research group, with this objective in mind. In our laboratory, stable products are analyzed by gas chromatography, with sample compression for enhanced sensitivity. Intermediates are quantified by molecular beam analysis, a synthesis of mass spectrometry with molecular beam measurements. Finally, an attempt is being made to combine the effects of the discharge parameters into a single variable, conveniently measured by the decomposition of trace amounts of a discharge "actinometer" which is added to the system.

### MOLECULAR BEAM ANALYSIS

Although intermediates in post-discharge flowing gases have been quantified by a variety of methods, very few of these techniques have been successfully applied directly to discharge environments, due to the special properties of such regions (e.g. free charges, light emission, corrosion and polymer deposition). Mass spectrometry, however, appears to be generally useful for this purpose, especially for low pressure discharges, where representative sampling presents little difficulty. The utility of mass spectrometry for monitoring ions in discharges is obvious, and great sensitivity can be achieved in such measurements.<sup>3</sup> For neutral intermediates (e.g. atoms or free radicals), ionization by electron or photon bombardment is required, with concomitant reduction in sensitivity. In order to ensure the survival of unstable intermediates, the sampled gas usually enters the ionization region as a collimated molecular beam, which passes through several separately pumped chambers in order to maintain a low residual pressure in the ionizer. Modulation of the molecular beam is helpful to further discriminate against ions formed from background gas.

Although a mass spectrometer allows unambiguous

identification of ions (in the limit of infinite  $m/e$  resolution), identification of the neutral parent of each ion requires considerable care. Atoms and free radicals are usually identified by the method of appearance potential discrimination, i.e. the formation of ions with electrons of energy lower than that needed to produce the atomic or free radical parent ion by any fragmentation process<sup>4-6</sup> (see Table 1). Since the cross-section for direct ionization (I) approaches zero at threshold, discrimination against dissociative ionization (II) is facilitated by a large bond energy. However, one must consider not only the bond energy of the reactant RX (II), but also of all products, RY, some of which may be more weakly bound (III). Ion-pair formation (IV) has a threshold reduced by the electron affinity of the negative ion-forming moiety, and for electronegative substituents, may occur at lower energies than direct ionization (I). Loss of discrimination due to thermal energy (V) and mutual repulsion of electrons (VI) can be eliminated by the use of photo-ionization,<sup>7</sup> or reduced by means of the retarding-potential-difference method<sup>8</sup> or deconvolution techniques.<sup>9</sup>

There is both theoretical<sup>10</sup> and experimental<sup>11</sup> evidence that molecules become vibrationally excited in electric discharges, and also that vibrational energy,  $W(RX^*)$ , is completely effective in lowering the appearance potential for dissociative ionization of molecules.<sup>12</sup> Thus, process VII can be particularly troublesome in discharges, where vibrational temperatures are generally unknown, especially in case where the reactants have sufficient vibrational degrees of freedom to store appreciable vibrational energy. In conclusion, appearance potential discrimination can be employed to quantify intermediates in

discharges, but careful attention must be paid to potential interferences from process II-VII.

In our laboratory an alternative mass spectrometric procedure is employed for identifying transient intermediates in chemical reactions. The method is termed molecular beam analysis, because it uses molecular beam measurements of the properties of neutral species to supplement ionic mass data.<sup>13</sup> The molecular beam analyzer, shown in Fig. 1, employs a 45°, 15-cm radius magnetic sector mass spectrometer, with an electron multiplier detector and either a pulse counting or a current measuring data handling system. Since appearance potential discrimination is not employed, ions can be formed with a very intense beam of electrons (*ca.* 200 mA) of energy close to that at which ionization cross-sections are maximized.

The molecular beam is modulated in the source chamber at 78 Hz by a rotating sectored disk. In the main chamber a moveable obstacle blocks the direct path into the ionizer. Particles are then deflected into the ionizer by the inhomogeneous hexapolar field shown in Fig. 2. This field can serve as either a magnetic or electric lens. In the

Table 1. Appearance potential discrimination

Process	Minimum energy
I $R + e \rightarrow R^+ + 2e$	$V = I(R)$
II $RX + e \rightarrow R^+ + X + 2e$	$V = I(R) + D(RX)$
III $RY + e \rightarrow R^+ + Y + 2e$	$V = I(R) + D(RY)$
IV $RX + e \rightarrow R^+ + X^- + e$	$V = I(R) + D(RX) - EA(X)$
V thermal energy of electrons	
VI space charge effects	
VII $RX^* + e \rightarrow R^+ + X + 2e$	$V = I(R) + D(RX) - W(RX^*)$

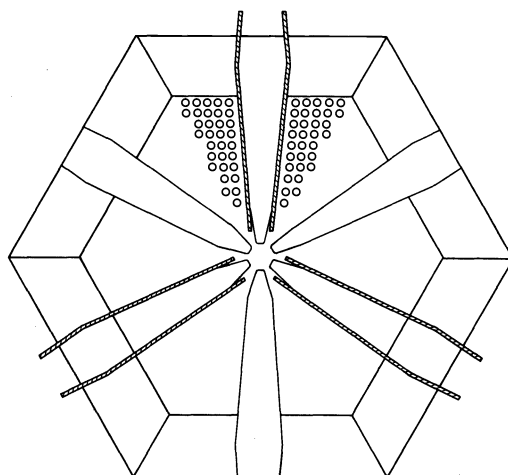

Fig. 2. End view of the hexapolar electromagnetic-electrostatic field. The energizing coils are only shown around one of the pole tips.

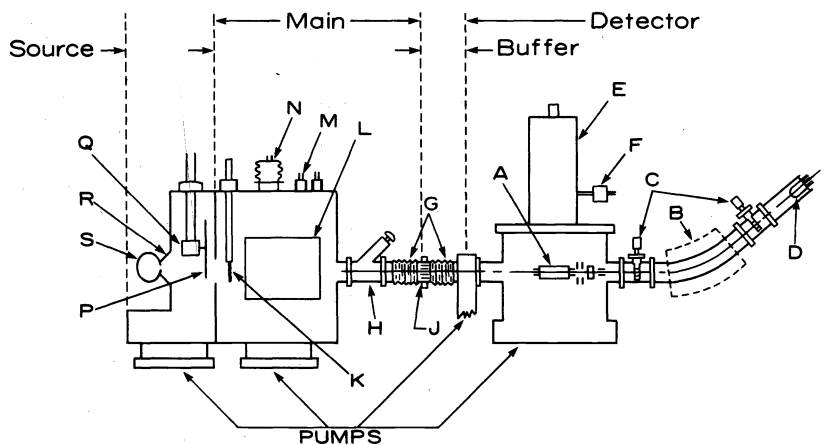

Fig. 1. Side view of molecular beam analyzer; (A) electron bombardment ionizer; (B) magnet pole tips; (C) variable-width slits; (D) electron multiplier; (E) cryopump; (F) variable leak valve; (G) flexible metal bellows; (H) straight-through valve; (J) directional entrance; (K) moveable obstacle; (L) hexapolar electromagnetic-electrostatic field; (M) feed-throughs (9) for water-cooled magnet coils; (N) high-voltage feedthrough; (P) beam modulator or pulsor; (Q) motor; (R) source mounting cone; (S) flowtube; See Ref. 13 for additional details of this apparatus.

magnetic configuration, each of the pole tips is energized by currents of up to 50 A flowing through 32 turns of 1/8-in. o.d. water-cooled copper tubing, to produce fields of *ca.* 5000 G between the pole tips. Only particles with magnetic moments of the order of a Bohr magneton (free radicals and some atoms and excited states) can be focused into the ionizer by this field. Three of the poles of the magnet are electrically insulated by 1/16-in. thick Teflon sheet. Voltages up to 20 kV are applied to these three electrodes when using the field as an electric lens to direct polar molecules into the ionizer.

Differences in the ease with which various species are focused by the hexapolar magnetic field can aid in identifying the species. The force exerted by the field on a particle depends on its magnetic moment in a space-fixed coordinate system, which is determined by the number of unpaired electrons in the particle and the degree to which the magnetic moment produced by these electrons is averaged to zero by molecular rotation. Thus, in Fig. 3, it is not surprising that some nitrogen atoms are focussed at very low magnetic field strength, since the nitrogen atom has three unpaired electrons. Hydrogen atoms and methyl radicals each have a single unpaired electron, and the focussing behaviors of these species are similar. Oxygen molecules have two unpaired electrons. However, the strong internuclear field in this molecule largely quantizes the magnetic moment of the electrons along the internuclear axis. The rotation of this diatomic molecule then reduces the moment in the space-fixed coordinate system.

By substituting a slotted disk for the sectored disk rotating in the source chamber, the molecular beam may be pulsed instead of modulated. The time dependence of the signal then provides a time-of-flight (TOF) distribution, from which the velocity distribution of the neutral species can be extracted. If the pressure in the reactor is low enough for flow through the sampling orifice to be effusive, the velocity distribution is determined by the translational temperature in the source and the mass of the neutral species, according to the Maxwellian distribution function. A linear relationship between the time to the peak of the TOF curve and the square root of the mass of the neutral is then obtained.<sup>13</sup> Under these conditions, the TOF distribution permits low resolution measurements of the mass of the neutrals before they are perturbed by dissociative processes in the ionizer. At higher pressures, the flow through the orifice is hydrodynamic, with the

velocities of all particles in the beam approaching the same value.

An example of TOF curves used in a discharge study is shown in Fig. 4. Curve A is the TOF distribution at  $m/e = 1$  for an undischarged  $H_2$  beam. It is characteristic of the mass of the neutral, i.e. 2 amu. When the microwave discharge is initiated, the TOF curve, shown in B, shows an unresolved component at earlier mass, corresponding to  $amu = 1$ , i.e. the hydrogen atoms produced in the discharge. Curves C, D, and E are taken on the discharged gas with the obstacle in place and 5, 30, and 45 A respectively on the focussing magnet. As the focussing field increases, more rapidly moving hydrogen atoms are

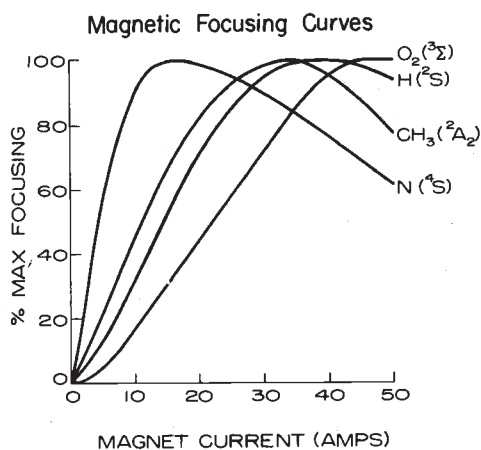

Fig. 3. Relative magnetic focusing of various paramagnetic particles as a function of the energizing current of the hexapolar electromagnet.

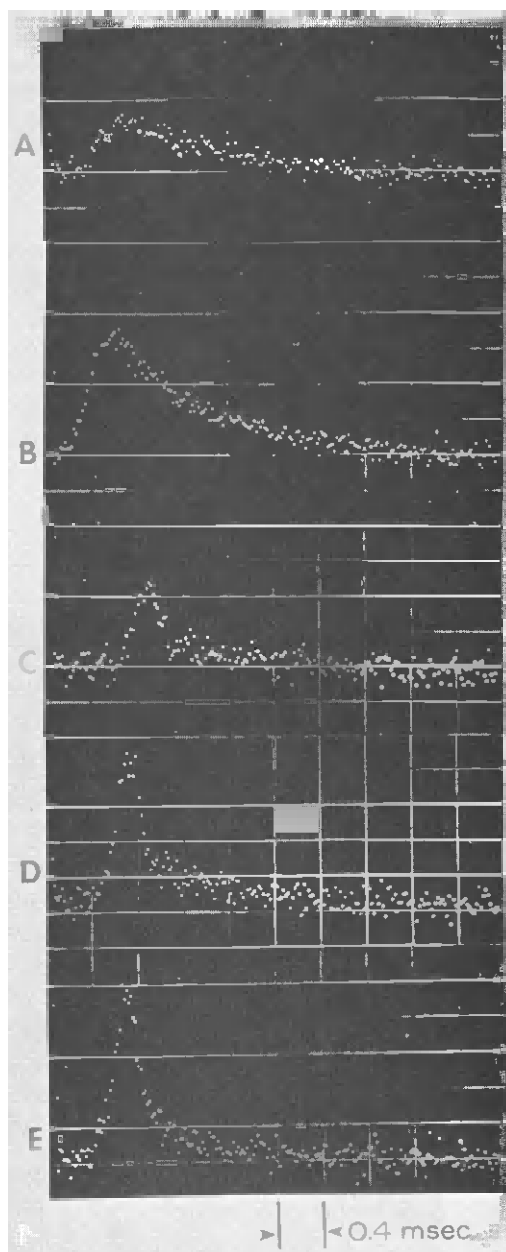

Fig. 4. Time-of-flight distribution for discharged  $H_2$  at  $m/e = 1$ : (A) discharge off, straight-through beam; (B) discharge on, straight-through beam; (C-E) discharge on, direct beam blocked, focussing magnet current 15A (C), 30A (D) and 45A (E), 50 W microwave discharge,  $P = 0.5$  torr.

focussed. Only a single peak is seen in these magnetically focussed TOF curves, since hydrogen atoms with spin  $1/2$ , have only one orientation which is focussed in the field. This can be compared with the more complicated magnetically-focussed TOF curve obtained for fluorine atoms ( $^2P_{3/2}$  ground state and  $^2P_{1/2}$  low-lying excited state), shown in Fig. 5. These curves, which have a higher information content than either simple TOF distributions or velocity integrated focussing curves (Fig. 3), are extremely useful for identifying paramagnetic intermediates.

#### INTERMEDIATES IN DISCHARGES

As indicated in Table 2, quite a few intermediates in discharge systems have been detected by means of molecular beam analysis. Although some of these intermediates have been observed in discharges through the pure reagent, usually the reagents are diluted to 1–5% in an inert carrier gas (He, Ar or  $N_2$ ) at total pressures of 0.3–2 torr. The microwave discharge is maintained in a small tuned cavity<sup>14</sup> and has a high power density (ca. 20 W/cm<sup>3</sup>). Intermediates are sampled downstream of this

discharge. For organic molecules, in order to reduce fragmentation and tar formation, an r.f. discharge, with much lower power density (ca. 0.01–0.1 W/cm<sup>3</sup>) is generally employed. Intermediates can be sampled either downstream of the r.f. discharge or directly from the discharge region, using one of the two configurations shown in Fig. 6. In Fig. 6a, parallel-plate capacitive coupling is employed, with one of the plates containing a hole, where the square cross-section quartz flow tube is joined to the molecular beam analyzer by means of an O-ring vacuum seal. Since with this design, sampling is from a boundary layer at the flow tube wall, low concentrations are measured for intermediates which are effectively destroyed at the wall. In the arrangement shown in Fig. 6b, the gas is rapidly flowing towards the aluminium oxide cone, thus reducing the boundary layer thickness at the sampling orifice, with resulting sampling of larger concentrations of wall-sensitive intermediates.

As an example of an exploratory study performed with the configuration shown in Fig. 6b, the concentrations of methyl radicals produced in an r.f. discharge through acetone are shown in Fig. 7. Over a fairly wide range

Table 2. Intermediates observed in discharges by molecular beam analysis

Species	Discharge	Reagent
H, N, O, F, Cl, Br	Microwave	$X_2$ and other compounds
ClO	Microwave	$Cl_2 + O_2$
SO, S <sub>2</sub> O	Microwave	SO <sub>2</sub>
CF <sub>3</sub>	r.f.	$C_2F_6$ , $(CF_3)_2CO$ , $CF_3OCO_2CF_3$
C <sub>2</sub> F <sub>5</sub>	r.f.	$C_2F_6$ , $(CF_3)_2CO$ , $CF_3OCO_2CF_3$
OCF	r.f.	$CF_3OCO_2CF_3$
CH <sub>3</sub>	r.f.	$(CH_3)_2CO$
CCl <sub>3</sub>	r.f.	CCl <sub>4</sub>
SiCl <sub>3</sub>	r.f.	SiCl <sub>4</sub>

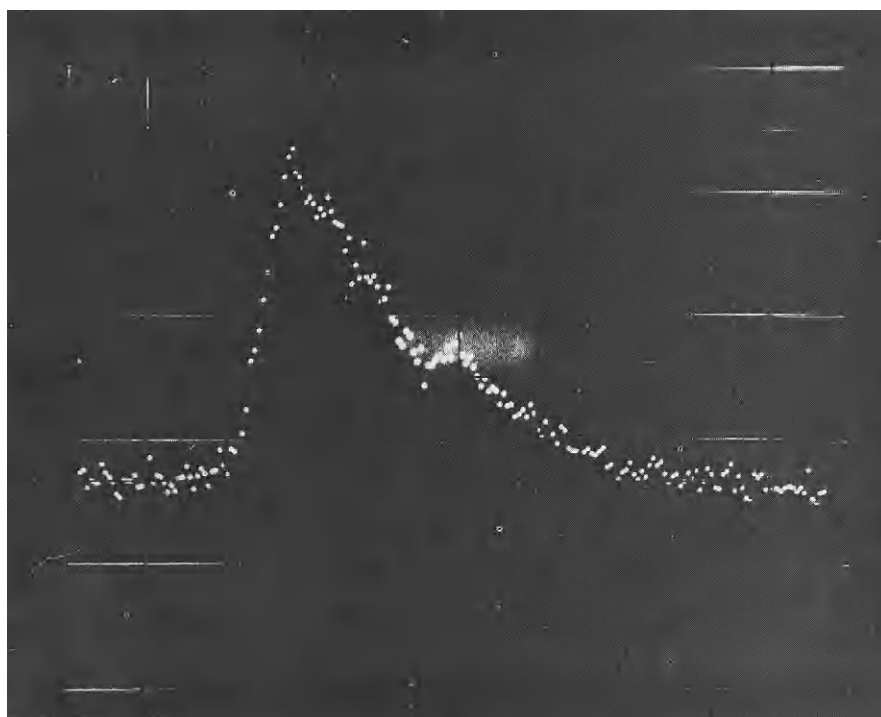

Fig. 5. Time-of-flight distribution of discharged  $F_2$  (8%) in He at  $m/e = 19$ ,  $P = 0.3$  torr, 50 W microwave discharge, direct beam blocked, focusing magnet current 40A.

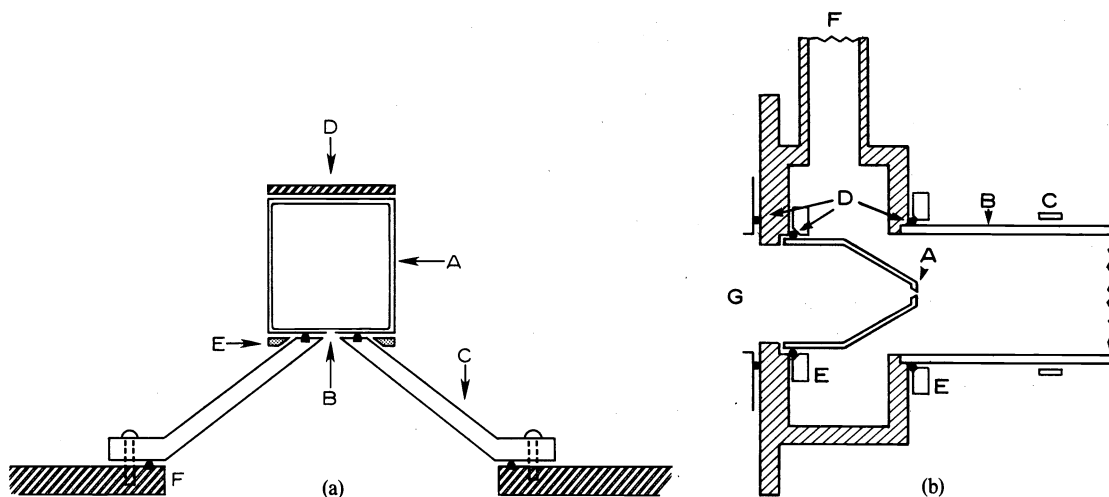

Fig. 6. Arrangements for sampling directly from r.f. discharges. (a) A—square cross-section quartz flow tube; B—sampling orifice; C—mounting cone; D—grounded capacitor plate; E—capacitor plate; F—molecular beam analyzer. (b) A—aluminum oxide sampling cone; B—quartz flow tube; C—r.f. electrode; D—O-ring seals; F—to pump; G—molecular beam analyzer.

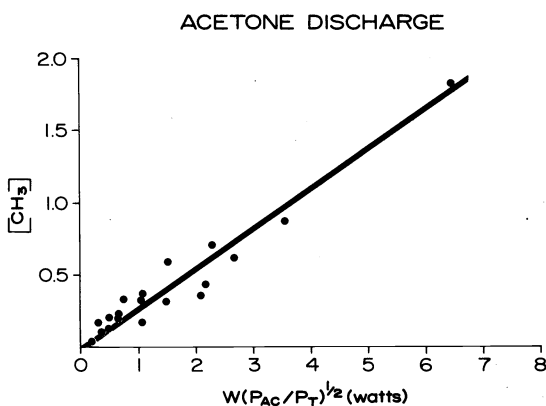

Fig. 7. Relative methyl radical concentrations in an acetone discharge. Variation of variables:  $W$ , 1–20 W;  $P_{acetone}$ , 0.006–0.038 torr;  $P_{total}(Ar)$ , 0.4–0.8 torr.

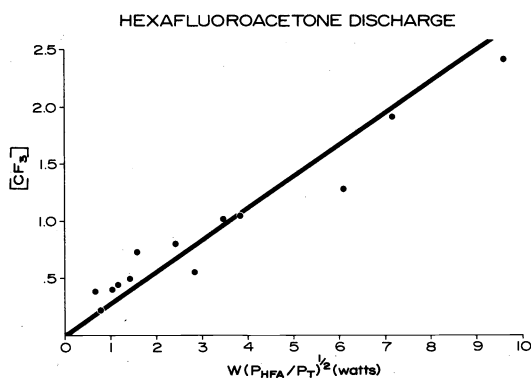
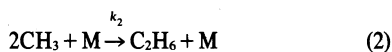
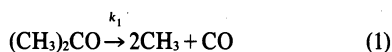

Fig. 8. Relative trifluoromethyl radical concentrations in a hexafluoroacetone discharge. Variation of variables:  $W$ , 3–24 W,  $P_{hexafluoroacetone}$ , 0.016–0.064 torr;  $P_{total}(Ar)$ , 0.4–0.09 torr.

of power (1–20 W) and of acetone partial pressure (0.006–0.038 torr) and with a factor of two in variation in total pressure (0.4–0.8 torr), the measured methyl radical concentration varies approximately linearly with the variable  $W(P_{acetone}/P_{total})^{1/2}$ . Figure 8 shows that roughly the same result is obtained when monitoring  $CF_3$  radicals in a hexafluoroacetone discharge. It is interesting to compare these results with those predicted by a steady-state kinetics analysis for the simplest conceivable mechanism for such reactions, where radicals are produced directly by the discharge and lost by homogeneous termolecular recombination.



$$\frac{d[CH_3]}{dt} = 0 = 2k_1[(CH_3)_2CO] - 2k_2[CH_3]^2[M] \quad (3)$$

$$[CH_3] = \left( \frac{k_1 [(CH_3)_2CO]}{k_2 [M]} \right)^{1/2}$$

With the assumption of negligible heating or consumption of reactant, this gives the same dependence on  $P_{acetone}$  and  $P_{total}$  as is observed. If  $k_2$  is assumed to be independent of discharge power, agreement with the experimental power dependence is obtained if  $k_1$  is proportional to  $W^2$ . The most important deficiency of this analysis is its neglect of consumption of reactant (equating the initial concentration of reagent to the instantaneous concentration required in eqn 3). This may be responsible for the three points with largest  $[CF_3]$  in Fig. 8 falling somewhat below the line, and the experimental procedure is currently being altered so as to be able to account for reagent consumption. We consider the reasonable agreement of our results with this very simple kinetics analysis to be extremely encouraging.

#### ELECTRIC DISCHARGE ACTINOMETERS

The second part of this paper deals with the question of what discharge parameters are most useful in making correlations in order to reveal the mechanisms of transformation in plasma chemistry. I would like to suggest that in answering this question, we follow the lead of photochemists, who make useful correlations on the basis of quantum yields. In photochemistry, the dependence of

the quantum yield of a process on the chemical parameters of a system can often disclose the transformations of active intermediates produced in the reaction, in the absence of knowledge concerning the primary photochemical event. Often, at a later date, a photochemical reaction is re-investigated with more sophisticated techniques, which reveal the details of its initial steps.

The use of quantum yields presupposes a knowledge of the number of interactions between the source of excitation and the reactants. In photochemistry, this is clearly the number of quanta absorbed by the reactant, but what is the corresponding quantity in discharge chemistry, which we will call the "intensity" of the discharge? In some discharge systems, it may be possible to use the consumption of reactant as a measure of the intensity. For example, in the previously discussed mechanism,  $\ln \left( \frac{[(\text{CH}_3)_2\text{CO}]_0}{[(\text{CH}_3)_2\text{CO}]} \right) = k_1 \tau$ , where  $\tau$  is the residence time in the discharge. Thus eqn (3) can be rearranged to

$$[\text{CH}_3] = \left( \frac{1}{k_2 \tau} \ln \left( \frac{[(\text{CH}_3)_2\text{CO}]_0}{[(\text{CH}_3)_2\text{CO}]} \right) \times \frac{[(\text{CH}_3)_2\text{CO}]^{1/2}}{[\text{M}]} \right), \quad (4)$$

which is independent of discharge parameters. However, this approach will obviously be invalid in cases in which there is appreciable back reaction, chain reaction, or quenching of a reactive or dissociating state. In such instances, we propose the use of a discharge actinometer, i.e. a molecule which is destroyed in a simple manner by the discharge and can be added to plasma reactions in order to measure the rate of primary interactions between the discharge and substrates. It is emphasized that, in contrast to photochemistry, in plasma chemistry the actinometer must be incorporated into the system being studied—no substitution of vessels is permitted, due to the strong coupling between the chemical and discharge parameters of a plasma system.

There are a number of important requirements for discharge actinometers. First, such molecules must be destroyed only by direct interaction with the electrons and photons of the discharge and not by reaction with active particles produced from the substrate, such as atoms or free radicals. (When an inert carrier gas is employed, it seems appropriate to include destruction by collision with inert gas ions and excited states as direct interactions of the discharge.) Second, the ratio of the rates of primary interaction of the actinometer and substrate with the discharge must be a constant as discharge conditions are varied. The latter requirement might seem like an impossibly difficult criterion to satisfy, since the interaction of molecules with electrons and photons are often strongly energy dependent. However, in discharges one must consider averages over broad distributions of energy, and these might show much less variation. For example, some results for an r.f. discharge in Ar to which varying amounts of tetrahydrofuran and hexafluoroacetone have been added are shown in Fig. 9. Along each axis is plotted a quantity proportional to the first-order constant for destruction of one of the substrates. Within the normal experimental error for this type of experiment, these data are fitted by a straight line; i.e. over the range of variables used in this experiment, the ratio of constants for destruction of the two reagents is independent of conditions. A similar linear relationship has been found for discharges containing hexafluoroacetone

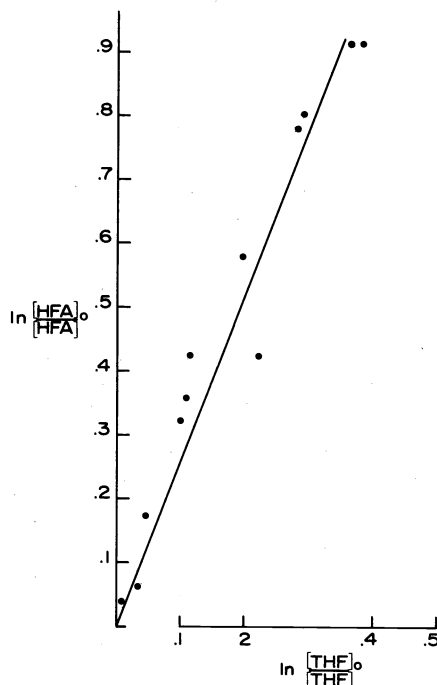

Fig. 9. Two substrate discharge, hexafluoroacetone and tetrahydrofuran,  $P_{\text{hexafluoroacetone}} \approx 0.0018$  torr,  $P_{\text{tetrahydrofuran}} \approx 0.020$  torr,  $P_T = 0.4-0.8$  torr,  $W = 1.7-12.6$  W,  $\tau \approx 0.025$  sec.

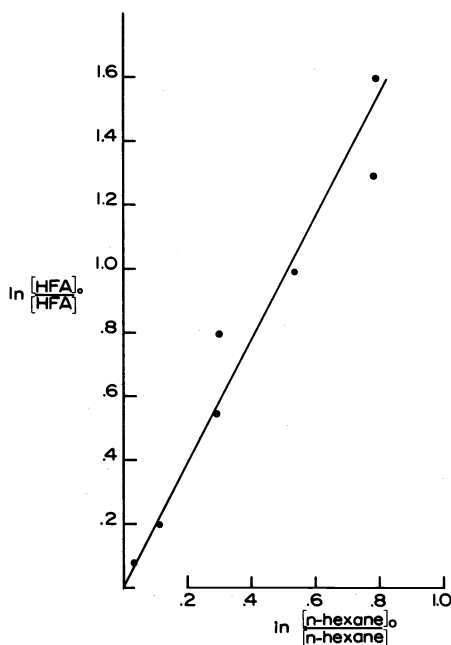

Fig. 10. Two substrate discharge, hexafluoroacetone and *n*-hexane,  $P_{\text{hexafluoroacetone}} \approx 0.0035$  torr,  $P_{\text{n-hexane}} \approx 0.017$  torr,  $P_T = 0.5-1.0$  torr,  $W = 1.2-13.2$  W,  $\tau \approx 0.025$  sec.

and *n*-hexane, as shown in Fig. 10. Such data encourages us in our search for appropriate discharge actinometers.

#### END-PRODUCT ANALYSIS

The measurements shown in Figs. 8 and 9 were made by mass spectrometrically (with the molecular beam analyzer) monitoring characteristic ions of these compounds

sufficiently far down-stream of an r.f. discharge to permit vibrational relaxation of excited molecules. Besides being an extremely expensive technique, mass spectrometry also suffers from limited accuracy in monitoring trace concentrations of actinometers ( $P \ll 0.001$  torr) and interferences at ions characteristic of many products. A more conventional method of end-product analysis, such as gas chromatography, would thus be useful in our work. Unfortunately, we find that even with the extremely sensitive flame ionization detector, the sensitivity of gas chromatography is insufficient to accurately monitor the concentration of trace products and actinometers in these low pressure discharge systems. This results from the maximum volume of the low pressure gas that can be employed as a sample (usually *ca.* 1 cm<sup>3</sup>) without degrading the resolution of the method. An alternative procedure is to trap the discharge effluent and then dissolve the trace compounds. However, this procedure can be exceedingly time consuming.

In our laboratory we have developed a simple method for compressing low pressure gaseous samples to atmospheric pressure, with proportional increases in the partial pressure of trace components, in order to provide a large increase in sensitivity for gas chromatographic analyses. The increase in sensitivity is  $P_{\text{atm}}/P_{\text{sample}}$ , and usually is greater than 100. Sample compression is accomplished in a Teflon bag which is sequentially evacuated, filled with low pressure sample, isolated, and then compressed by atmospheric pressure. Using this technique, we can quickly and accurately quantify discharge products having partial pressures of  $<10^{-3}$  torr.

Although we have not yet completed the detailed analysis of any plasma reaction, we are hopeful that with the promising diagnostic techniques described in this report, we will be able to make some meaningful progress

in this direction. Perhaps we are not far from the day in which mechanisms of plasma transformations will be discussed with the same degree of confidence as they are presently for other, older methods of carrying out chemical reactions.

*Acknowledgements*—Many of the experiments described in this report were performed by Drs. Barry Hertzler and Lester Wei. Financial support of our research by the Office of Naval Research is greatly appreciated. Acknowledgement is made to the Donors of the Petroleum Research Fund, administered by the American Chemical Society, for partial support of this research.

#### REFERENCES

- <sup>1</sup>J. B. Anderson, *J. Chem. Phys.* **61**, 3390 (1974), and references cited therein.
- <sup>2</sup>H. Suhr, *Angew. Chem. Int. Edit.* **11**, 781 (1972).
- <sup>3</sup>G. Smolinsky and M. J. Vasile, *Int. J. Mass Spect. Ion Phys.* **16**, 137 (1975).
- <sup>4</sup>F. P. Lossing, in *Mass Spectrometry* (edited by C. A. McDowell) McGraw-Hill, New York (1963).
- <sup>5</sup>S. N. Foner, *Adv. Atom. Molec. Phys.* **2**, 385 (1965).
- <sup>6</sup>W. L. Fite, *Int. J. Mass Spect. Ion Phys.* **16**, 109 (1975).
- <sup>7</sup>I. R. Slagle, J. R. Gilbert and D. Gutman, *J. Chem. Phys.* **61**, 704 (1974).
- <sup>8</sup>R. E. Fox, W. M. Hickam, D. J. Grove and T. Kjeldaas, *Rev. Sci. Instr.* **12**, 1101 (1975).
- <sup>9</sup>J. Berkowitz and W. A. Chupka, *J. Chem. Phys.* **50**, 4245 (1969).
- <sup>10</sup>M. Burton and K. Funabashi, in: *Chemical Reactions in Electrical Discharges, Advance in Chemistry*. Series No. 80, p. 140. American Chemical Society (1969).
- <sup>11</sup>J. H. Kim and E. R. Thorton, *J. Am. Chem. Soc.* **97**, 1865 (1975).
- <sup>12</sup>W. A. Chupka, *J. Chem. Phys.* **54**, 1936 (1971).
- <sup>13</sup>M. Kaufman and C. E. Kolb, *Chemical Instr.* **3**, 175 (1971).
- <sup>14</sup>F. C. Fehsenfeld, K. M. Evenson and H. P. Broida, *Rev. Sci. Instr.* **36**, 294 (1965).