

INDUSTRIAL APPLICATION OF IMMOBILIZED ENZYME SYSTEMS

Ichiro Chibata

Research Laboratory of Applied Biochemistry, Tanabe Seiyaku
Co., Ltd., 16-89, Kashima-3-chome, Yodogawa-ku, Osaka, JAPAN

Abstract — Industrial applications of immobilized enzymes and immobilized microbial cells for the production of L-amino acids and organic acids are presented. Continuous optical resolution of acyl-DL-amino acid is efficiently carried out using an immobilized aminoacylase column. L-Aspartic acid and L-malic acid are continuously produced using columns of immobilized *Escherichia coli* and immobilized *Brevibacterium ammoniagenes*, respectively. These continuous production systems are superior to the conventional batch-wise processes using soluble enzymes or intact cells.

INTRODUCTION

Enzymes, which are very efficient and advantageous catalysts, can catalyze specific reactions under mild conditions, i.e. in neutral aqueous solution at room temperature. However, they are not always ideal catalysts for industrial application. In some cases, the above mentioned advantages of enzymes turn to disadvantages as catalysts. Namely, enzymes are generally unstable, and can not be used in organic solvents or at elevated temperatures.

One of the approaches to prepare more superior catalysts for application purpose is immobilization of enzymes. The definition of immobilized enzyme is "physical confinement or localization of enzyme molecule with retention of its catalytic activity, so that it can be used repeatedly and continuously". Over the past ten years, the immobilization of enzyme has been the subject of increased interest, and a number of papers on potential applications of immobilized enzymes have been published. Very recently papers on the immobilization of microbial cells also have appeared. However, practical industrial systems using immobilized enzymes and immobilized microbial cells have been very limited.

In 1969, we succeeded in the industrial application of an immobilized enzyme, i.e., immobilized aminoacylase, for the continuous production of L-amino acids from acetyl-DL-amino acids. This new procedure is the first industrial application of immobilized enzymes in the world. Since then we also have carried out the industrial application of immobilized microbial cells for the continuous production of L-aspartic acid and L-malic acid. In this paper these three industrialized examples of immobilized systems are described.

IMMOBILIZED ENZYME

— PRODUCTION OF L-AMINO ACIDS BY IMMOBILIZED AMINOACYLASE —

Utilization of L-amino acids for medicine and food has been developing rapidly in recent years. For the industrial production of L-amino acids, fermentation and chemically synthetic methods have a promising future. However, chemically synthesized amino acids are optically inactive racemic mixtures of L- and D-isomers. To obtain natural L-amino acid from the chemically synthesized DL-form, optical resolution is necessary. Among the many optical resolution methods, the enzymic method using mold aminoacylase is one of the most advantageous procedures, yielding optically pure L-amino acids as follows:

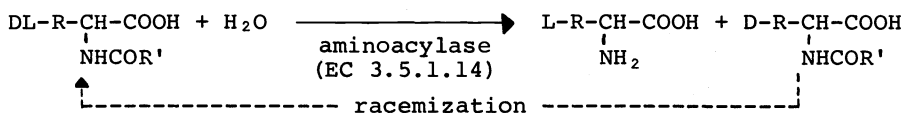

A chemically synthesized acyl-DL-amino acid is asymmetrically hydrolyzed by aminoacylase to give L-amino acid and unhydrolyzed acyl-D-amino acid. Both compounds are easily separated by the difference of their solubilities. Acyl-D-amino acid is racemized, and reused for the resolution procedure. This mold aminoacylase has versatile substrate specificity, and many kinds of acyl-DL-amino acids can be asymmetrically hydrolyzed.

From 1954 to 1959, this enzymic resolution method was employed by Tanabe Seiyaku Co., for the industrial production of several L-amino acids. The enzyme reaction was carried out batchwise by incubating a mixture containing substrate and soluble enzyme. However, this procedure had some disadvantages inherent in the batch process using soluble enzyme. For instance, in order to isolate L-amino acid from the reaction mixture, we had to remove enzyme protein by pH and/or heat treatments. These resulted in uneconomical use of the enzyme. In addition, as complicated purification procedures were necessary for removal of contaminating proteins and colored substances, the yield of L-amino acids was lowered. Also much labor was necessary for the batch operation. To overcome these disadvantages and to improve this procedure, we studied extensively the continuous optical resolution of DL-amino acids using a column packed with immobilized aminoacylase (Ref. 1-9). When we started this study in early 1960ies, reports on enzyme immobilization were very few and practically no reports on application of immobilized enzymes existed.

Preparation of immobilized aminoacylase

A variety of methods for immobilization of aminoacylase suitable for industrial purpose were investigated.

As the result, relatively active and stable immobilized aminoacylases were obtained by ionic binding to DEAE-Sephadex, covalent binding to iodoacetyl-cellulose and entrapping into polyacrylamide gel lattice.

TABLE 1. Characteristics of immobilized aminoacylase

Preparation	Ionic	Covalent	Entrapping
Characteristics	(DEAE-Sephadex)	(Iodoacetyl cellulose)	(Polyacrylamide)
Preparation	easy	difficult	moderate
Enzyme activity	high	high	high
Cost of immobilization	low	high	moderate
Binding force	moderate	strong	strong
Regeneration	possible	impossible	impossible
Operational stability (Half-life*)	65 days, at 50°C	—	48 days, at 37°C

* Time required for 50% of the enzyme activity to be lost.

For the industrial application of immobilized aminoacylase, many conditions should be satisfied. Some of these criteria for the three immobilized aminoacylases are compared in Table 1. Besides the activity of immobilized enzyme, the operational stability of the immobilized enzyme and the regenerability of deteriorated immobilized enzyme columns after long periods of operation are important for industrial application. The ionically bound DEAE-Sephadex-aminoacylase was chosen as the most advantageous enzyme preparation for the industrial production of L-amino acids, because preparation is easy, activity is high and stable, and regeneration is possible.

Industrial application of DEAE-Sephadex-aminoacylase complex

In order to design the most efficient enzyme column, we investigated the flow system for the substrate solution, the effect of column dimensions on the reaction rate, and the pressure drop through the enzyme column.

From these studies an enzyme reactor system was designed for continuous production of L-amino acids with immobilized aminoacylase. The flow diagram is shown in Fig. 1. Substrate, that is acetyl-DL-amino acid solution, is continuously charged into an enzyme column through filter and heat exchanger by chemical pump at a constant flow rate. During passing through the column, the substrate is converted to L-amino acid and acetyl-D-amino acid. Enzyme column effluent is concentrated, and L-amino acid is crystallized. Acetyl-D-amino acid remaining in mother liquor is racemized by heating in racemization tank, and reused for optical resolution. This system is automatically controlled and operated continuously.

The aminoacylase column maintained about 70% of the initial activity after 30 days of operation, and the half-life of the column was estimated to be about 65 days. This result indicated that the column was very stable and was sat-

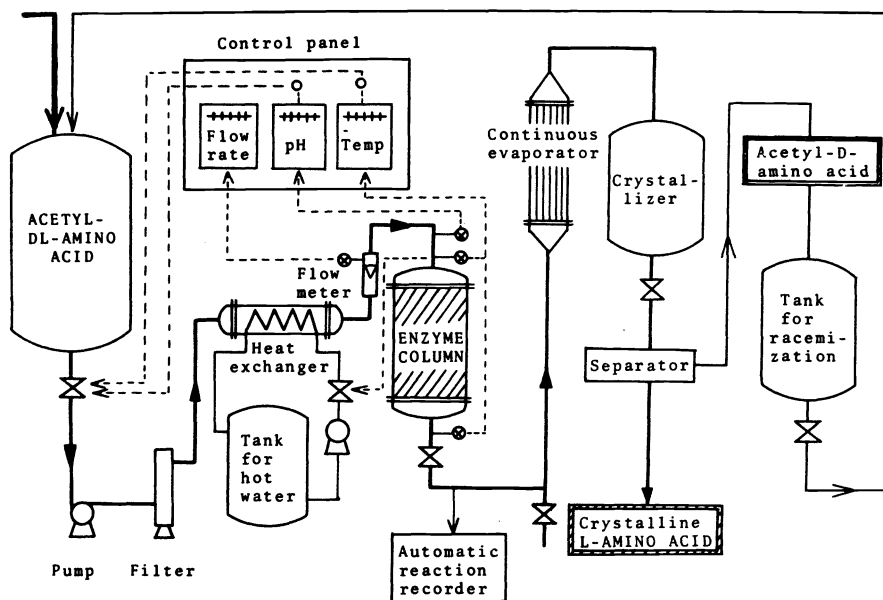

Fig. 1. Flow diagram for continuous production of L-amino acid by immobilized aminoacylase.

isfactory for industrial application. As mentioned before, the regeneration of a deteriorated column is very important. In the case of aminoacylase column, it was completely reactivated by the addition of the amount of aminoacylase corresponding to the deteriorated activity. This regenerability is one of the merits of ionic binding method for the immobilization of enzyme, and this is especially advantageous when the carrier and enzyme are expensive. Since the water-insoluble carrier DEAE-Sephadex has been much more stable than we had expected, it has been used for over 8 years without significant loss of binding capacity or physical decomposition. A typical comparison of the cost for production of L-amino acids is shown in Fig. 2. With the immobilized enzyme, the purification procedure for product became simpler and the yield was higher than in the case of the soluble enzyme.

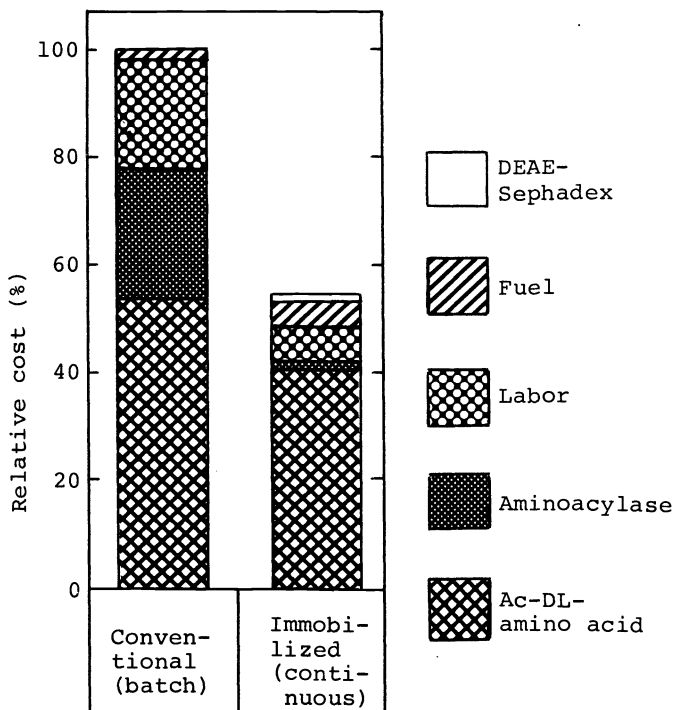

Fig. 2. Comparison of cost for production of L-amino acids.

Therefore, less substrate was required for the production of a unit amount of L-amino acid. As the immobilized aminoacylase was very stable, the cost of enzyme was markedly reduced compared with that of the soluble enzyme. In the case of immobilized enzyme, the process was automatically controlled, and the labor cost was also dramatically reduced. The overall production cost of the immobilized enzyme process was about 60% of that of the conventional batch process using soluble enzyme.

Since the summer of 1969, we have been industrially operating several series of enzyme reactors in our plants for the production of L-methionine, L-valine, L-phenylalanine and so forth.

Preparation of immobilized tannin-aminoacylase (Ref. 10)

In this aminoacylase method, L-amino acid and unhydrolyzed acyl-D-amino acid are separated after concentration of the column effluent. Therefore, if higher concentration of substrate can be used, the cost for concentration is more reduced. However, since the aminoacylase is ionically bound to DEAE-Sephadex, some leakage of enzyme occurs when the substrate of higher concentration is employed. Thus, in order to overcome this limitation and to improve the immobilized aminoacylase procedure, we have been carrying out extensive studies. And recently, we have succeeded to prepare the adsorbent suitable for immobilization of the enzyme.

This adsorbent is a kind of immobilized tannin, namely, it has tannin as a ligand and specifically adsorbs proteins. The preparation method is schematically shown in Fig. 3. That is, water-insoluble matrix such as cellulose is aminoalkylated, and tannin is activated by cyanogen bromide. By the reaction of aminoalkyl cellulose with activated tannin, immobilized tannin is prepared. Immobilized tannin-aminoacylase preparation is obtained by mixing the immobilized tannin and aminoacylase solution.

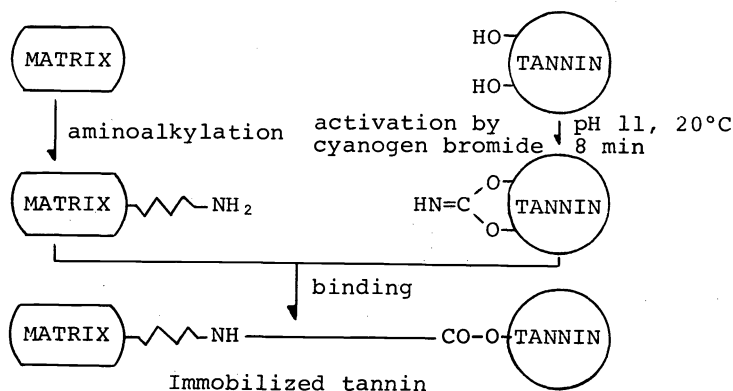

Fig. 3. General method for immobilization of tannin.

The productivity per unit volume of this immobilized aminoacylase is better by a factor of more than 2 as compared with DEAE-Sephadex-aminoacylase. Further, higher concentration of substrate can be used in the case of immobilized tanninaminoacylase. Therefore, this method will be promising for industrial application.

IMMOBILIZED MICROBIAL CELLS

Production of L-aspartic acid by immobilized *Escherichia coli* (Ref. 11-13)

L-Aspartic acid is used for medicines and food additives, and it has been industrially produced by fermentative or enzymic methods from ammonium fumarate using the action of aspartase:

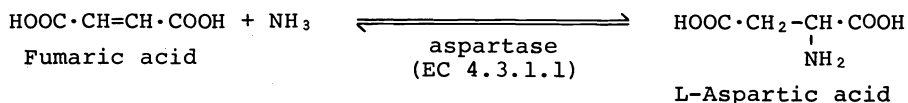

This reaction has been carried out by a batch procedure, which has disadvantages for industrial purpose just as in the case of the native aminoacylase process. Thus, we studied the continuous production of L-aspartic acid using a column packed with immobilized aspartase. As the aspartase is an intracellular enzyme, it was necessary to extract the enzyme from microbial cells before

immobilization. Extracted intracellular enzyme is generally unstable, and most of the immobilization methods we tried resulted in low activity and poor yield. Although entrapment into polyacrylamide gel lattice gave relatively active immobilized aspartase, its operational stability was not satisfactory (Ref. 14). Therefore, this immobilized aspartase was not satisfactory for the industrial production of L-aspartic acid.

So we considered that if the whole microbial cells could be immobilized directly, these disadvantages might be overcome. From this point of view, we studied the immobilization of whole microbial cells, and we succeeded in industrialization of this technique in 1973.

Immobilization of *Escherichia coli*. Reports on immobilization of whole microbial cells had been very scarce at that time, so we tried various methods for immobilization of *E. coli*.

Among the methods tested, the most active immobilized *E. coli* cells were obtained by entrapping the cells into polyacrylamide gel lattice.

An interesting phenomenon was observed with these immobilized cells. When the immobilized *E. coli* cells were suspended at 37°C for 24-48 hours in substrate solution, their activity increased by a factor of 10. The increase of enzyme activity was observed even in the presence of chloramphenicol, inhibitor of protein synthesis. Therefore, this activation was considered not to be the result of protein synthesis but to be due to increased permeability for substrate and/or product caused by autolysis of *E. coli* cells in the gel lattice. This was confirmed by the electron micrographs of immobilized *E. coli* cells, which indicated that lysis of cells had occurred.

Even when lysis of the cells did occur, the aspartase could not leak out from the gel lattice. But the substrate, ammonium fumarate, and the product, L-aspartate, passed easily through the gel lattice.

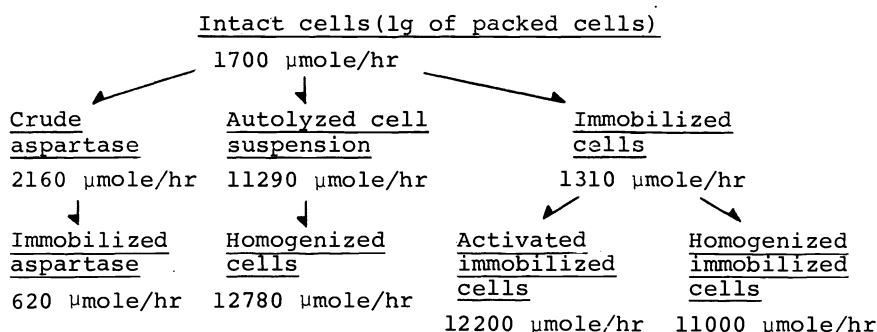

Fig. 4. Comparison of aspartase activity of various enzyme preparations from intact cells.

Aspartase activities of various preparations per unit of intact cells are compared in Fig. 4. The data show that the activated immobilized cells are advantageous in comparison with immobilized aspartase for the industrial production of L-aspartic acid. The aspartase activity of autolyzed cell suspension was as high as that of the activated immobilized cells, but the stability was low.

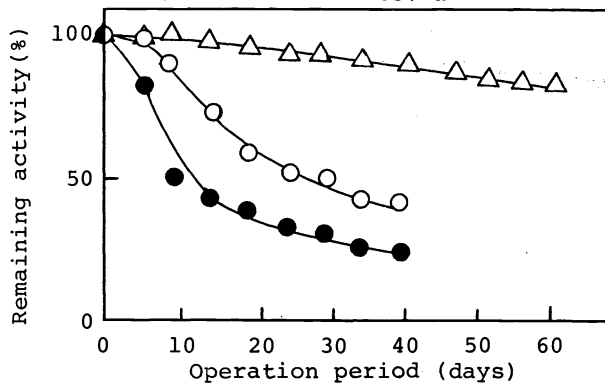

Fig. 5. Stability of various aspartase preparations. Half-lives of enzyme activity at 37°C were 120 days for immobilized cells (Δ), 30 days for immobilized enzyme (\circ), and 10 days for intact cells (\bullet), respectively.

Figure 5 shows the comparison of operational stability of various preparations. Immobilized cells are most stable. The half-life of the immobilized cell column was estimated to be 120 days at 37°C. Therefore, it is clear that the immobilized cell method is very advantageous for industrial purpose.

Industrial application of immobilized *Escherichia coli*. Conditions for continuous production of L-aspartic acid from ammonium fumarate using a column packed with immobilized *E. coli* cells were investigated in detail, and an aspartase reactor system was designed. The system is essentially the same as that for the immobilized aminoacylase system. That is, a solution of 1 M ammonium fumarate (containing 1 mM MgCl₂, pH 8.5) is passed through the immobilized *E. coli* cell column at a flow rate of SV=0.6 hr⁻¹ at 37°C. Pure L-aspartic acid is obtained, by adjusting the effluent to pH 2.8, in a 95% yield. The overall production cost of the immobilized cell system is about 60% of that of the conventional batch process using intact cells. Furthermore, the procedure employing immobilized cells is advantageous from the standpoint of waste treatment. Therefore, it is clear that this new technique is very efficient and superior to the conventional fermentative or enzymic technique. We have been industrially operating this new system in our plant for automatic and continuous production of L-aspartic acid since the autumn of 1973. This is considered to be the first industrial application of immobilized microbial cells in the world.

Production of L-malic acid by immobilized *Brevibacterium ammoniagenes* (Ref. 15 & 16)

L-Malic acid is an essential compound in cellular metabolism and is mainly used in pharmaceutical field. L-Malic acid can be produced by fermentative or enzymatic methods from fumaric acid by the action of fumarase:

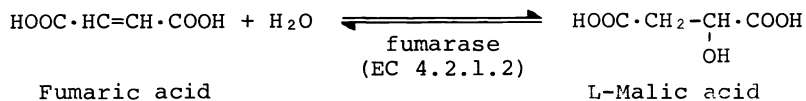

In this case, reaction reaches an equilibrium when about 80% of fumaric acid are converted to L-malic acid. We investigated continuous fumarase reactions using immobilized microbial cells.

Immobilization of *Brevibacterium ammoniagenes*. Several microorganisms having high fumarase activity were immobilized by polyacrylamide gel method and their activities were investigated. *B. ammoniagenes* showed the highest activity before and after immobilization.

However, when immobilized *B. ammoniagenes* was used for the production of L-malic acid from fumaric acid, some by-products were formed. Besides remaining fumaric acid, considerable accumulation of succinic acid was observed in the reaction mixture. Although fumaric acid can be easily separated by acidifying the reaction mixture, separation of succinic acid from L-malic acid is very difficult. Therefore, the point of success for industrial production of pure L-malic acid is the prevention of succinic acid formation during the enzyme reaction. So, we tried various methods to suppress succinic acid formation.

Among the methods tested the detergent treatment of immobilized cells was found to be promising as shown in Table 2. Immobilized cells kept at 37°C for 20 hours in the substrate solution containing a detergent produced more L-malic acid.

This result indicates that the detergent treatment is effective to remove permeability barrier for substrate and/or product across the membrane of cells entrapped into the polyacrylamide gel.

For the purpose to suppress succinic acid formation, ordinary detergents were not effective, while the detergents used as the solubilizers for membrane- or particle-bound enzymes (bile extract, bile acid and deoxycholic acid) were found to be effective to decrease succinic acid formation. From these results, we studied the detailed conditions for bile extract treatment, and found the most favorable conditions. That is, concentration of bile extract is over 0.2%, temperature is 37°C, and pH is around 7.5.

Figure 6 summarizes the fumarase activity of *B. ammoniagenes* after various treatments. Intact cells show very low fumarase activity due to low permeability of the substrate and/or product across the cell membrane. In the presence of CPC, cetylpyridinium chloride or by sonication of the cells, the activity of L-malic acid formation is increased. Immediately after the immobilization, membrane barriers still remain, but by incubating with substrate

TABLE 2. Effect of detergent treatments on formation of L-malic acid and succinic acid by immobilized *B. ammoniagenes*

Treatment ^{a)}	L-Malic acid ($\mu\text{moles/hr/g}$ of cells)	Succinic acid (mole % of L-malic acid) ^{c)}
Control ^{b)}	490	
No addition	990	2.5-5.0
CPC 0.02%	4570	2.5-5.0
" 0.16	3070	1.0-2.5
SLS 0.02	6050	1.0-2.5
SL-10 0.02	1220	2.5-5.0
Triton X-100 0.20	5360	>5.0
Bile extract 0.20	7480	<0.2
Bile acid 0.20	6570	<0.2
Deoxycholic acid 0.20	7380	<0.2

a) Stood at 37°C for 20 hr in 1M sodium fumarate (pH 7.5) containing detergent.

b) Immediately after preparation of the gel.

c) Estimated by ppc after the reaction reached equilibrium.

solution containing bile extract, activity of L-malic acid formation is increased and succinic acid formation can be decreased. The activity of intact cells rapidly decreases and its half-life is 6 days. On the other hand, immobilized cells treated with bile extract are very stable and half-life is 55 days at 37°C, indicating the advantage for L-malic acid production.

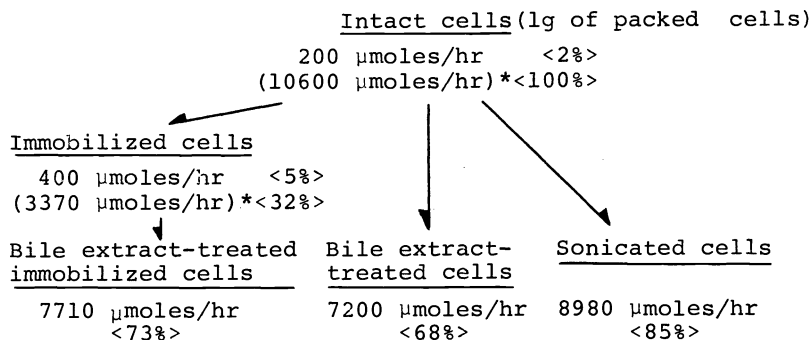

Fig. 6. Comparison of fumarase activity after various treatments of intact cells.

()*: Activity in the presence of 0.02% CPC.

Industrial application of immobilized *Brevibacterium ammoniagenes*. Then the conditions for continuous production of L-malic acid by a column packed with the immobilized cells was studied. When 1 M sodium fumarate (pH 7.0) is passed through the column at 37°C at flow rate, $SV=0.2\text{h}^{-1}$, the reaction reaches an equilibrium. From the effluent of the column, L-malic acid can be obtained by ordinary methods. Average yield of pyrogen-free pure L-malic acid from consumed fumaric acid is around 70% of the theoretical. We are operating this production system since 1974, and we are satisfied both with the economical efficiency and with the quality of product.

Other applications of immobilized microbial cells

Besides the two industrial applications of immobilized microbial cells above mentioned, we studied efficient continuous methods for the production of organic compounds by using immobilized cells as follows:

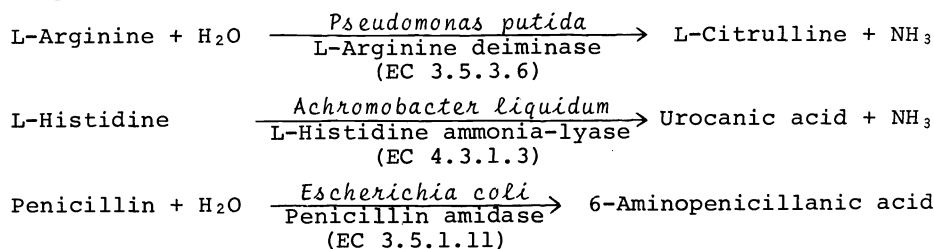

Immobilization of respective microorganisms was carried out by polyacrylamide gel method. As the results, important pharmaceutical compounds such as L-citrulline (Ref. 17), urocanic acid (Ref. 18) and 6-aminopenicillanic acid (6-APA) (Ref. 19) could be continuously produced in higher yield by immobilized cell systems.

Immobilization of microbial cells with carrageenan (Ref. 20)

As described above, the polyacrylamide gel method is advantageous for immobilization of microbial cells and for industrial application. However, there are some limitations in this method. That is, some enzymes are inactivated during immobilization procedure by the action of acrylamide monomer, β -dimethylaminopropionitril, potassium persulfate or heat of the polymerization reaction. Therefore, this method has limitation in application for immobilization of enzymes and microbial cells. Thus, to find a more general immobilization technique and to improve the productivities of immobilized microbial cell systems we studied new immobilization techniques. As the results, we have found that kappa carrageenan is very useful for immobilization of cells. Carrageenan is a kind of polysaccharide prepared from seaweed. It is non-toxic compound and is used in food. The principle of this method is that a mixture of carrageenan solution and cell suspension is cooled or contacted with ions such as K^+ , NH_4^+ , Ca^{++} , etc. The merits of this method are simplicity, high yield of enzyme activity on immobilization, and high operational stability of immobilized cells.

CONCLUSION

By our experience in industrialization of one immobilized enzyme system and two immobilized microbial cell systems, I think utilization of immobilized microbial cells for continuous enzyme reactions has advantages over immobilized enzyme systems in the following cases: 1) When enzymes are intracellular, 2) When enzymes extracted from the cells are unstable, 3) When enzymes are unstable during and after immobilization, 4) When microorganism contains no interfering enzymes, 5) When interfering enzymes are readily inactivated or removed, and 6) When substrates and products are not higher molecular compounds.

Another aspect to be considered is the volume of liquid to be processed. For the unit production of a desired compound, the required volume of fermentation broth is much smaller in the case of the continuous method using immobilized cells than in the case of conventional batch fermentative methods. Thus, the continuous process using immobilized cells is very advantageous from the point of reducing plant pollution problem. Also, in the case of batch fermentative methods feedback inhibition sometimes occurs by accumulated compounds, whereas this inhibition can be avoided in the continuous process.

REFERENCES

1. T. Tosa, T. Mori, N. Fuse, and I. Chibata, *Enzymologia* **31**, 214-224 (1966).
2. T. Tosa, T. Mori, N. Fuse, and I. Chibata, *Enzymologia* **31**, 225-238 (1966).
3. T. Tosa, T. Mori, N. Fuse, and I. Chibata, *Enzymologia* **32**, 153-168 (1967).
4. T. Tosa, T. Mori, N. Fuse, and I. Chibata, *Biotech. Bioeng.* **9**, 603-615 (1967).
5. T. Tosa, T. Mori, N. Fuse, and I. Chibata, *Agr. Biol. Chem.* **33**, 1047-1052 (1969).
6. T. Tosa, T. Mori, and I. Chibata, *Agr. Biol. Chem.* **33**, 1053-1059 (1969).
7. T. Tosa, T. Mori, and I. Chibata, *Enzymologia* **40**, 49-63 (1971).
8. T. Tosa, T. Mori, and I. Chibata, *J. Ferment. Technol.* **49**, 522-528 (1971).
9. T. Mori, T. Sato, T. Tosa, and I. Chibata, *Enzymologia* **43**, 213-226 (1972).
10. T. Mori, T. Watanabe, T. Tosa, and I. Chibata, *Abstract of the Annual Meeting of the Agricultural Chemical Society of Japan*, p.296 (1977).
11. I. Chibata, T. Tosa, and T. Sato, *Appl. Microbiol.* **27**, 878-885 (1974).
12. T. Tosa, T. Sato, T. Mori, and I. Chibata, *Appl. Microbiol.* **27**, 886-889 (1974).
13. T. Sato, T. Mori, T. Tosa, I. Chibata, M. Furui, K. Yamashita, and A. Sumi, *Biotechnol. Bioeng.* **17**, 1797-1804 (1975).
14. T. Tosa, T. Sato, T. Mori, Y. Matuo, and I. Chibata, *Biotech. Bioeng.* **15**, 69-84 (1973).
15. K. Yamamoto, T. Tosa, K. Yamashita, and I. Chibata, *Europ. J. Appl. Microbiol.* **3**, 169-183 (1976).

16. K. Yamamoto, T. Tosa, K. Yamashita, and I. Chibata, *Biotech. Bioeng.* 19, 1101-1114 (1977).
17. K. Yamamoto, T. Sato, T. Tosa, and I. Chibata, *Biotech. Bioeng.* 16, 1589-1599 (1974).
18. K. Yamamoto, T. Sato, T. Tosa, and I. Chibata, *Biotech. Bioeng.* 16, 1601-1610 (1974).
19. T. Sato, T. Tosa, and I. Chibata, *Europ. J. Appl. Microbiol.* 2, 153-160 (1976).
20. T. Tosa, T. Sato, T. Mori, K. Yamamoto, I. Takata, Y. Nishida, and I. Chibata, Abstract of International Congress of Pure and Applied Chemistry, at Tokyo, September 4, p.267 (1977).