

## Radical thermochemistry and organic reactions<sup>★</sup>

David Griller and Danial D. M. Wayner

Division of Chemistry, National Research Council of Canada, Ottawa,  
Ontario, K1A 0R6, Canada

**Abstract** - Most free radicals are transient species and it is therefore difficult to measure their thermochemical properties. We have used two new techniques that address this problem. Photoacoustic calorimetry was used to measure heats of formation of free radicals and thus homolytic bond strengths, while photomodulated voltammetry was used to measure their oxidation and reduction potentials. The data offer fresh insights into the thermochemistry of free radical processes and can therefore be used to design new reactions.

### INTRODUCTION

Almost all of the free radicals that participate in important chemical processes are short lived and it has therefore been particularly difficult to quantify their thermodynamic properties. Nevertheless, these quantities are of critical importance in the understanding of atmospheric and combustion chemistry and in the design of new free radical reactions.

Most of the currently available measurements on radical heats of formation and bond strengths have been made using gas kinetic techniques (ref. 1 & 2). This has meant that they are restricted to volatile and hence low molecular weight materials. In addition, the experiments have generally been carried out at high temperatures and often flawed by wall reactions, by assumptions about elements of the reaction kinetics and by the difficulties associated with extrapolation of the results to 300 K.

The first part of this paper describes a new technique, photoacoustic calorimetry, which overcomes many of these deficiencies and that can be used to produce reliable heats of formation and bond strengths for a wide variety of free radicals including high molecular weight and organometallic species.

While heats of formation of free radicals and homolytic bond strengths are crucial to a thorough understanding of many free radical reactions, it is being increasingly recognized that one electron transfer reactions involving radicals play a vital role in biological chemistry and in some industrially important processes such as photoimaging. In this context, gas phase measurements of the related thermodynamic quantities, i.e. ionization potentials and electron affinities are of little value since they cannot readily be extended to the condensed phases where these reactions take place. In fact, electrochemical oxidation and reduction potentials of free radicals are the parameters that are needed. While some have been measured by pulse radiolysis techniques the amount of available data is extremely limited and certainly does not satisfy the needs of chemists interested in biology or synthesis.

The second part of this paper deals with the technique of photomodulated voltammetry which we have developed to measure oxidation and reduction potentials for transient free radicals. As we will see, these can be combined with heats of formation and bond strengths to provide a unified description of the thermodynamic properties of free radicals and their related ions.

---

<sup>★</sup>Issued as NRCC publication no. 29376

### PHOTOACOUSTIC CALORIMETRY

The photoacoustic method that we have used is designed for the measurement of heats of reactions in solution where a transient species is one of the reaction products. Although the photoacoustic effect has been the subject of extensive theoretical investigation, this particular application requires no theory since all of its elements can be tested empirically.

The design of our apparatus (ref. 3) follows closely upon that developed by Peters and his colleagues (ref. 4). Thanks to their help and encouragement, we were able to establish the technique in our own laboratory to make measurements on free radical reactions. Our calorimeter is shown schematically in Fig. 1.

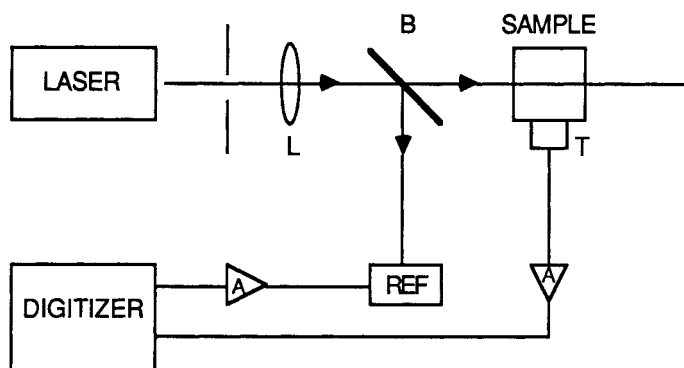

Figure 1. Block diagram of the photoacoustic calorimeter. A, preamplifier; B, beam splitter; L, lens; T, piezoelectric transducer.

The apparatus and the experiment itself are extremely simple. Pulses from a nitrogen laser (337 nm;  $h\nu = 84.8 \text{ kcal mol}^{-1}$ ) are passed through an iris that is used to select only a small segment of the light. The minor extent of divergence associated with the beam is corrected using a low powered lens and a few percent of the light is deflected by a beam splitter to a reference detector that is used to monitor variations in the laser power. This function of this part of the apparatus is to deliver low intensity pulses of laser light that have a small (ca. 1.0 mm) beam diameter.

The pulses finally pass through the sample cell. This is a standard uv flow cell that contains a solution of a substrate which can be photolyzed to give free radicals. For example, suppose that the cell contains a solution of di-*tert*-butyl peroxide in carbon tetrachloride. On each laser pulse a fine beam of light passes through the cell and peroxide molecules that are in its trajectory each adsorb a photon of light. Each molecule has then taken in the energy equivalent of  $84.8 \text{ kcal mol}^{-1}$ . Approximately,  $38 \text{ kcal mol}^{-1}$  are used to cleave the oxygen-oxygen bond, eq. 1, and the remainder



are liberated as heat. The release of heat into the solvent causes a shock wave which is transmitted at the speed of sound to the cell wall. When it hits the wall it causes a vibration which is detected by a sensitive piezoelectric transducer with microsecond time resolution, that is clamped to the cell. The initial shock wave is followed by many reflections which disappear after a few milliseconds. However, it is the first wave that is of interest.

The amplitude of the first wave is proportional to the amount of heat liberated in the reaction. This is easily demonstrated by changing the concentration of the light absorbing material or by attenuating the laser light intensity using neutral density filters and by demonstrating that the amplitude of the peak is proportional to the amount of light absorbed. Attenuating the laser beam also demonstrates that radical-radical reactions do not contribute to the thermochemistry on the timescale of the experiment. The rates of these reactions depend upon the square of the radical concentration and would therefore produce a non-linear response.

The method is not restricted to primary photochemical processes of the kind described in eq. 1. In fact we have used the *tert*-butoxyl radicals formed in this process to abstract hydrogen from a series of donors, eq. 2. So long as reactions 1 and 2 are complete in a time that is short with respect to the



response of the calorimeter, the sum of the heats of these reactions are accurately measured. In practice this requires that the rate for hydrogen abstraction is  $10^7 \text{ M}^{-1} \text{ s}^{-1}$  or greater. This is easily verified by varying the concentration of the hydrogen donor and demonstrating that the heat of reaction is independent of its concentration or it can be established from a prior knowledge of the reaction rate constant.

The combined heats of reactions 1 and 2 can be converted to bond dissociation energies for the hydrogen donors, BDE(R-H), by introducing the heats of formation of di-*tert*-butyl peroxide, *tert*-butyl alcohol and the hydrogen atom (ref.3, eq. 3 to 5). Bond dissociation energies obtained by this method are shown in Table 1 (ref. 3 & 5).

$$\Delta H_{1+2} = 2\Delta H_f(t\text{-BuOH}) + 2\Delta H_f(\text{R}\cdot) - 2\Delta H_f(\text{RH}) - \Delta H_f(t\text{-BuOOBu-}t) \quad (3)$$

$$\text{BDE}(\text{R-H}) = \Delta H_f(\text{R}) + \Delta H_f(\text{H}\cdot) - \Delta H_f(\text{RH}) \quad (4)$$

$$\text{BDE}(\text{R-H}) = (\Delta H_{1+2})/2 - 2\Delta H_f(t\text{-BuOH}) + \Delta H_f(t\text{-BuOOBu-}t) + \Delta H_f(\text{H}\cdot) \quad (5)$$

The first three entries establish the usefulness of the photoacoustic approach since only very crude estimates existed in the literature for the bond strengths in 1,4-cyclohexadiene and tributyltin hydride. Those measured for diethyl ether and triethyl silane were in good agreement with the literature values.

Table 1. Bond Dissociation Energies, BDE(R-H), Measured by Using Photoacoustic Calorimetry at 300 K

R-H	BDE(R-H)	
	kcal mol <sup>-1</sup>	lit. kcal mol <sup>-1</sup>
Bu <sub>3</sub> SnH	73.7 ± 2.0	74 <sup>a</sup>
1,4-cyclohexadiene	73.0 ± 2.0	74 ± 5 <sup>b</sup>
EtOEt	92.5 ± 2.0	91.7 ± 0.4 <sup>c</sup>
Et <sub>3</sub> SiH	90.1 ± 2.0	90.3 ± 1.0 <sup>d</sup>
Me <sub>3</sub> Si(Me) <sub>2</sub> SiH	85.3 ± 2.0	
(Me <sub>3</sub> Si) <sub>3</sub> SiH	79.0 ± 2.0	

<sup>a</sup>Estimated; R.A. Jackson, *J. Organomet. Chem.* **166**, 17, (1979).

<sup>b</sup>Estimated for 1,3-cyclohexadiene (ref. 2).

<sup>c</sup>Ref. 2.

<sup>d</sup>Ref.6.

Comparing Si-H bond strengths in silanes with those of their hydrocarbon analogues is a fascinating exercise since the factors that affect C-H bond strengths have little influence on their silicon congeners. For, example phenyl substitution in carbon systems has a profound bond weakening effect; the C-H bond strength in toluene being ca. 16 kcal mol<sup>-1</sup> less than that in methane. By contrast, the Si-H bond strength in phenylsilane (88 kcal mol<sup>-1</sup>) is essentially equal to that in silane itself (90 kcal mol<sup>-1</sup>), (ref. 6).

Electron withdrawing or donating groups exert a very strong influence in silane thermochemistry. Thus, the replacing three hydrogens by fluorines in F<sub>3</sub>Si-H pushes up the bond strength to 100 kcal mol<sup>-1</sup>, while replacing one of the hydrogens by an SiH<sub>3</sub> group reduces the bond strength so that in BDE(H<sub>3</sub>SiSiH<sub>2</sub>-H) it is only 86 kcal mol<sup>-1</sup>. We pursued this last result and found that it held the key to the systematic reduction of bond strengths in silicon containing compounds.

Table 1 contains Si-H bond dissociation energies for silanes that were measured using the photoacoustic technique incorporating di-*tert*-butyl peroxide as the photolabile substrate, eq. 1,2. That for triethylsilane, is in excellent agreement with the gas phase literature for that compound,

while our measurements on pentamethyldisilane confirm that introduction of an electron releasing substituent weakens the Si-H bond. To find the limit for this effect, we linked three trimethylsilyl groups to the central silicon atom and found that in tris(trimethylsilyl)silane the bond dissociation energy was only 79 kcal mol<sup>-1</sup>.

We have also extended this sequence of reactions so as to measure a series of silicon halogen bond strengths. We generated the triethylsilyl radical via reactions 1 and 2 in the presence of alkyl halides. Since silyl radicals are extremely efficient halogen abstracting agents, reaction 6 takes

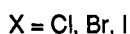
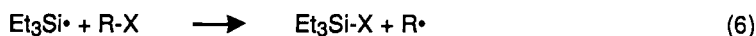

place within the timescale of the photoacoustic technique. The thermochemical measurement reflects the combined enthalpies for these reactions and since the heats of formation of simple alkyl radicals are known, the bond dissociation energies in the halides were evaluated. Preliminary results give BDE(R<sub>3</sub>Si-X) = 115, 95, 72 ± 2 kcal mol<sup>-1</sup> for X = Cl, Br and I respectively.

The rather low silicon hydrogen bond strength for the heavily substituted silicon compound tris(trimethylsilyl)silane confirms that the electron releasing substituents have a powerful effect in weakening the bond. However, from a practical point of view the Si-H bond strength in this compound is quite similar to the Sn-H bond strength in tributyltin hydride. Moreover, the silicon halogen bond strengths are (see above) high so that the results suggest that the silane might function as reducing agent. This expectation turned out to be correct and the silane functions as an efficient reducing agent in radical chain reactions (eq. 7,8). Moreover, it is toxicologically and

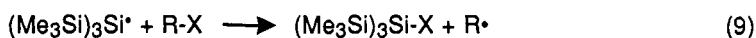
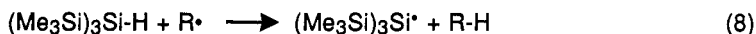

environmentally far more acceptable than the tin analogue and may indeed be a useful pharmacological application of free radical reactions.

### Solvent effects

One of the main criticisms that can be levelled at the photoacoustic approach is that the measurements are made in solution and therefore that the results are not transferable to the gas phase. These concerns seem to be mitigated by the good agreement between gas phase and solution data where comparison has been possible. The coincidence is not accidental. It probably stems from the fact that solvation energies of organic molecules in organic solvents are fairly small and that there is a cancellation effect, between the solvation energies of reactants and products, in a given reaction. If a sizeable hydrocarbon molecule is converted to a radical in a reaction, the loss of a single hydrogen is unlikely to induce a large change in the solvation energy. However, it is possible that solvation effects could become more pronounced in polar solvents. We therefore investigated the heats of some free radical reactions in water, (ref. 7).

The reaction scheme used in these experiments is shown in eq. 9 and 10. Hydroxyl radicals are

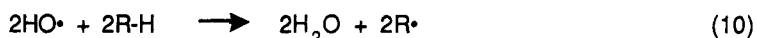

extremely potent abstracting agents so that these reactions are rapidly completed on the photoacoustic timescale. However, their high reactivity is accompanied by a loss in regioselectivity so that abstraction of hydrogen can occur at more than one site in a chosen molecule. We therefore selected substrate molecules that showed a high degree of regioselectivity in their reactions with hydroxyl (>80%) and made corrections to the measured heats of reactions that took account of abstraction at other sites. In practice, these corrections turned out to be ca. 1 kcal mol<sup>-1</sup> and were therefore of the order of the experimental errors (ref. 7).

Data for the combined heats of reactions 9 and 10 ( $\Delta\text{H}(\text{QH})_{\text{aq}}$ ) are given in Table II together with the values calculated from literature results for the reaction in the gas phase (ref. 7). It is immediately obvious that there is a large discrepancy. However, we persisted with the idea that the conversion of an organic molecule to its radical would not involve a significant change in solvation energy even in water and we looked elsewhere for the origin of this water versus gas phase difference.

Table II. Heats of Reactions 9 and 10 (kcal mol<sup>-1</sup>)  
Measured at 300 K in Water

Substrate	$\Delta H(\underline{C}H)_{aq}^a$	$\Delta H(\underline{C}H)_g^b$ lit	$\Delta H(\underline{C}H)_g^c$ this work
<u>C</u> H <sub>3</sub> OH	-11.4±0.7	1±4	-3.5±0.7
CH <sub>3</sub> <u>C</u> H <sub>2</sub> OH	-10.7±1.2	-1±2	-2.8±1.2
(CH <sub>3</sub> ) <sub>2</sub> <u>C</u> HOH	-16.4±0.7	-5±2	-8.5±0.7
(CH <sub>3</sub> ) <sub>3</sub> <u>C</u> OH	3.1±1.0	13±4	11.0±1.0
( <u>C</u> H <sub>2</sub> OH) <sub>2</sub>	-16.0±1.2	-10±2	-8.1±1.2
<u>C</u> H <sub>3</sub> COO <sup>-</sup>	-11.3±0.7	-	-3.4±0.7

<sup>a</sup>For C-H bond cleavage at the underlined position of the substrate.

<sup>b</sup>Ref. 6.

<sup>c</sup>After correction for solvation energies for hydrogen peroxide and water.

A major change in reactions 9 and 10 is that one molecule of hydrogen peroxide is converted to two of water. The heats of solvation of these molecules are known and the contribution to the observed heat from this particular solvation energy change is -7.9 kcal mol<sup>-1</sup>. When this contribution is factored into our data, the results are in good agreement with those from the gas phase. The correspondence between the two sets underscores the correctness of the hypothesis that the conversion of an organic compound to its corresponding radical is accompanied by a minimal change in solvation energy and that the major changes, in this instance, are associated with the smaller molecules in the system. In water this effect is bound to be pronounced since the conversion of a hydrogen peroxide into two molecules of water must involve a substantial change in the hydrogen bonded structure of the solvent.

With these results to hand, it was possible to calculate bond strengths for the reactions in water, eq. 4. When an allowance of 1 kcal mol<sup>-1</sup> was made for the solvation energy of the hydrogen atom in water, the agreement between gas phase and solution data was extremely good (ref. 7). The results demonstrate that gas phase and solution data can be easily interconverted if account is taken of solvation energies associated with an increase or decrease of the total number of molecules that participate in the reaction.

Overall, these initial experiments suggest that photoacoustic calorimetry could be an abundant source of thermodynamic data for transient species and, while measured in solution, these data are transferable to the gas phase.

### Electrochemistry of free radicals

Oxidation and reduction potentials of free radicals relate the thermodynamic properties of the radical to those of its corresponding ions. However, for carbon centered radicals, these parameters are particularly difficult to measure. One approach to their measurement is to begin the electrochemical experiment with an organic cation or anion and reduce or oxidize these to the radical. While the principle is simple, the practice is not since stable solutions of carbocations or carbanions are notoriously difficult to prepare and characterize. Our approach has been to begin the experiment with the free radical itself (ref. 8).

The apparatus that we have used is shown in Fig. 2. The sample cell was fitted with quartz windows and contained all of the necessary components for electrochemistry. The working electrode was a gold minigrid, the reference electrode was a saturated calomel electrode, the supporting electrolyte was normally tetrabutylammonium perchlorate and the solvent acetonitrile. The electrodes were controlled by a standard potentiostat. Radicals are generated by photolysis of appropriate substrates using a 1000 W mercury xenon lamp. Reactions 1 & 2 or 11 have been used



for this purpose and the solutions were flowed through the sample cell so as to avoid problems associated with substrate depletion or product formation. Despite the high light intensity and hence

high rate of radical generation, the radical concentration is limited by diffusion controlled radical - radical reactions. Under these conditions radical concentrations are ca.  $10^{-7}$  to  $10^{-8}$  M and average lifetimes are ca.  $10^{-3}$  s making conventional electrochemical detection impossible.

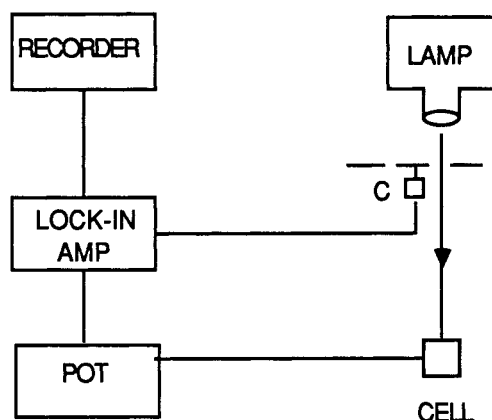

Figure 2. Block diagram of the photomodulation voltammetry apparatus. C, light chopper; POT, potentiostat.

We used a modulation technique to discriminate in favour of the radicals (Fig.2, ref. 8). Basically, the photolyzing light was modulated at a fixed frequency using a mechanical chopper. The radical concentration therefore increased and then diminished at the chopping frequency. The output of the potentiostat was fed to a phase sensitive detector that used the chopping frequency as a reference and therefore extracted the electrochemical response due to the radical from the contributions due to other components in the reaction mixture. The modulation technique provides signal-to-noise enhancements in favour of transient species that are ca.  $10^3$  to  $10^4$ .

By slowly scanning the voltage on the potentiostat, a voltammogram of the free radical is generated that shows waves for its oxidation and reduction. The half-wave potentials for oxidations and reductions of a variety of free radicals are shown in Table III. One of the key issues in the interpretation of these data in a thermodynamic sense, is to decide whether the potentials describe processes that are "electrochemically reversible". For this to be the case, radical and ion must exist in equilibrium at the electrode at all potentials; i.e. the electron transfer process must be under thermodynamic and not kinetic control.

One approach to dealing with this question is to measure, for example, the reduction potential of a radical and in a separate experiment, the oxidation potential of its corresponding anion. If the potentials are in good agreement, then the measured half-wave potentials are equivalent to the thermodynamically significant  $E^\circ$  value for the reaction.

As stated above, the amount of data available on the oxidation and reduction potentials of organic ions is extremely limited. Nevertheless, in those cases where comparisons have been possible (benzyl and arylmethyl radicals) those results correspond very closely to the potentials measured by our photomodulated voltammetry technique, suggesting that the data aryl and benzyl radicals are indeed thermodynamically significant.

The data can be combined in thermodynamic cycles to define relationships between free radicals and their corresponding ions. As an example we will focus attention on the oxidation and reduction potentials of the benzyl radical. However, the principles involved are quite general.

The oxidation potential of the benzyl radical can be used to define the bond energy in the bibenzyl radical cation. The thermodynamic cycle is described in eqs. 12 to 15.

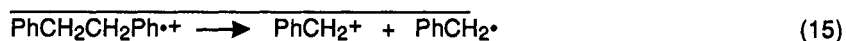

Table III. Electrochemical Properties of Free Radicals.<sup>a,b</sup>

Radical	$E_{1/2}^{\text{ox}}$	$E_{1/2}^{\text{red}}$	Radical	$E_{1/2}^{\text{ox}}$	$E_{1/2}^{\text{red}}$
$\text{Ph}\dot{\text{C}}\text{H}_2$	0.73	-1.45	$\text{CH}_3\text{CH}_2\text{O}\dot{\text{C}}\text{HCH}_3$	-0.45	(-1.2)
$\text{Ph}\dot{\text{C}}\text{HCH}_3$	0.37	-1.60	$(\text{CH}_3)_2\text{CHO}\dot{\text{C}}(\text{CH}_3)_2$	-0.10	-0.79
$\text{Ph}\dot{\text{C}}(\text{CH}_3)_2$	0.16	-1.73	Tetrahydrofuran-2-yl	-0.35	(-1.0)
$\text{Ph}_2\dot{\text{C}}\text{H}$	0.35	-1.14	1,4-dioxan-2-yl	-0.08	(-1.0)
$\text{Ph}_2\dot{\text{C}}\text{CH}_3$	0.23	-1.34	1,3-Dioxolan-2-yl	0.21 <sup>h</sup>	(-1.2)
9-Fluorenyl	0.76	-0.76	1,3-Dioxolan-4-yl	-0.34 <sup>h</sup>	(-1.2)
$(\text{CH}_3)\dot{\text{C}}$	0.09	c	1,3,5-Trioxan-2-yl	0.20	(-1.1)
4-methoxybenzyl	0.30	-1.75	$(\text{CH}_3)_2\text{N}\dot{\text{C}}\text{H}_2$	-1.03	(-2.0)
3-cyanobenzyl	1.11	-1.11	$(\text{CH}_3\text{CH}_2)_2\text{N}\dot{\text{C}}\text{HCH}_3$	-1.12	(-2.0)
4-acetylbenzyl	0.90	-0.71	$(\text{PhCH}_2)_2\text{N}\dot{\text{C}}\text{HPh}$	-0.92	-1.79
$(\text{CH}_3)_2\dot{\text{C}}\text{OH}$	-0.70	c	$\text{PhN}(\text{CH}_3)\dot{\text{C}}\text{H}_2$	-0.85	-2.03
$\text{CH}_3\text{O}\dot{\text{C}}\text{H}_2$	-0.24	(-1.3)			

<sup>a</sup> In acetonitrile, 0.10 M TBAP, gold minigrid. <sup>b</sup> All values  $\pm 50\text{mV}$  average of at least three determinations; values in parentheses are less reliable. <sup>c</sup> No definite reduction wave was observed.

If we assume that the entropy changes in eq. 13 and 15 are equal, the data yield the enthalpy for the cleavage, eq. 15. Interestingly, the value obtained ( $24\text{ kcal mol}^{-1}$ ) is within experimental error of that obtained from gas phase data ( $26\text{ kcal mol}^{-1}$ ) where ionization potentials take the place of the electrochemical oxidation potentials. The result implies that the solvation energies of the bibenzyl radical cation and the benzyl cation are essentially the same and supports the conclusions on solvation energies that were drawn from photoacoustic calorimetry.

Fig. 3 shows a more general application of the electrochemical data for the benzyl radical example. The values shown in bold face are measured values of free energy while those in italics are calculated using two of the measured values in the cycle. The data on the top line of the figure represent the oxidation and reduction potentials for the benzyl radical that were measured using the modulation technique. They been adjusted to reflect the absolute potential of the electrode (ref. 8). The data on the bottom line are the oxidation and reduction potentials of toluene as measured by conventional electrochemistry. Again, these are referred to the absolute potential of the electrode. The result that links the two sets is the free energy for C-H bond dissociation in toluene.

For clarity, we have not balanced the reactions to show the fate of the hydrogen that is eliminated in the reactions that transform a molecule on the bottom line of the figure to one on the top. In going diagonally from the lower left to the upper right, a proton is formed while in going vertically from bottom to top, a hydrogen atom is formed. The arrows indicate the direction in which energy is added to bring about the transformation of interest.

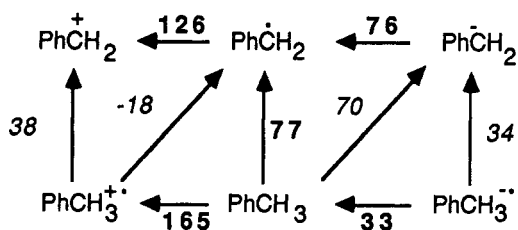
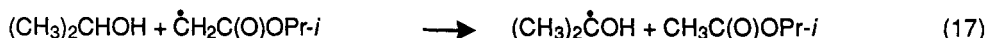
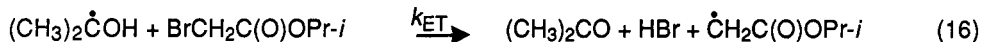

Figure 3. Thermochemical cycle showing the homolytic and heterolytic cleavage processes for toluene and its radical ions.

Thus, the five pieces of experimental data on the benzyl radical and toluene lead to the free energies for an additional four reactions that include the free energies for hydrogen and proton loss from the toluene radical cation and the free energy for the heterolytic cleavage of the C-H bond in toluene to give the benzyl anion and a proton. This value, which is in  $\text{kcal mol}^{-1}$ , can be multiplied by 0.728 to give the  $\text{pK}_a$  of toluene in acetonitrile ( $\sim 51$ , ref. 8). Interestingly, the value measured in dimethylsulfoxide is 42 (ref. 9). The difference between the two results is equal to the free energy for transfer of a proton between the two solvents which has been reported in the literature, and shows that the benzyl anion is solvated to the same extent in both media.

While these thermodynamic data have an intrinsic value of their own, it is of interest to know whether they can be used in the design of new organic reactions that involve one electron transfer (ET) processes. Table III shows that  $(\text{CH}_3)_2\dot{\text{C}}\text{OH}$  might be a suitable candidate for this purpose since it has a relatively low oxidation potential and is readily generated by hydrogen abstraction from isopropyl alcohol.

We tested the feasibility of this idea using a very simple system and attempted to reduce isopropyl-bromoacetate by such a process eq. 16, 17. The reactions were initiated using benzophenone



photolysis. The solvent was isopropanol and collidine was added as scavenger of hydrogen bromide.

The reaction worked extremely well. Product analysis showed that the chain length for the reaction was ca. 50 and kinetic analysis of its time dependence showed that the rate determining step involved electron transfer ( $k_{\text{ET}} \approx 5 \times 10^4 \text{ M}^{-1}\text{s}^{-1}$ ).

Of course, reducing a bromoacetate to an acetate is not a very useful transformation. However, the reaction is easily elaborated by the addition of an acetylene (eq. 18, 19). Now the sequence allows

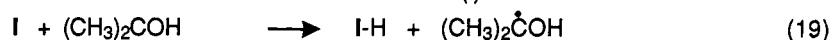
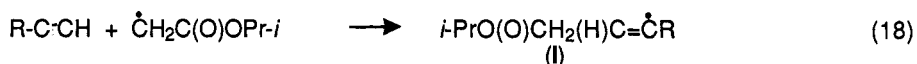

carbon-carbon bond formation in the development of a reaction product. We acknowledge that, at this stage these are relatively simple transformations. However, their success suggests that oxidation and reduction potentials of radicals can be used to design new reactions of synthetic utility.

### SUMMARY

The photoacoustic and photomodulation techniques described in this work provide fundamental data on the thermochemistry of free radical processes. The information can be combined to give a unified description of the relationships between free radicals and their ions and even yield data on heterolytic properties such as the acidities of hydrocarbons.

Initial experiments on the use of silanes as free radical reducing agents and hydroxyalkyl radicals as one electron donors suggest that the thermochemical data can be used in the rational design of new reactions for organic synthesis.

### Acknowledgement

We thank Dr. Larkin Kerwin for a President's award that made this work possible.

### REFERENCES

1. S.W. Benson, *Thermochemical Kinetics*, 2nd Edn. John Wiley, New York (1976).
2. D.F. McMillen and D.M. Golden, *Ann. Rev. Phys. Chem.*, **33**, 493 (1982).
3. T.J. Burkey, M. Majewski and D. Griller, *J. Am. Chem. Soc.*, **108**, 2218 (1986).
4. L.J. Rothberg, J.D. Simon, M. Bernstein and K.S. Peters, *J. Am. Chem. Soc.*, **105**, 3464 (1983). J.D. Simon and K.S. Peters, *J. Am. Chem. Soc.*, **105**, 5156 (1983). M. Bernstein, J.D. Simon and K.S. Peters, *Chem. Phys. Lett.*, **100**, 24 (1983).
5. J.M. Kanabus-Kaminska, J.A. Hawari and D. Griller, *J. Am. Chem. Soc.*, **109**, 5267 (1987).
6. R. Walsh, *Acc. Chem. Res.*, **14**, 246 (1981).
7. J.M. Kanabus-Kaminska, B.C. Gilbert and D. Griller, unpublished results.
8. D.D.M. Wayner, D.J. McPhee and D. Griller, *J. Am. Chem. Soc.*, **110**, 132 (1988).
9. F.G. Bordwell, *Pure Appl. Chem.*, **49**, 963 (1977).