

## Silent discharges for the generation of ultraviolet and vacuum ultraviolet excimer radiation

Ulrich Kogelschatz

ASEA BROWN BOVERI, Corporate Research, 5405 Baden, Switzerland

**Abstract** - Excimers, known from electron beam experiments and UV lasers, can also form in silent discharges, a discharge type used for large-scale ozone production. In this high pressure non-equilibrium discharge a dielectric barrier leads to the formation of localized short-lived microdischarges. Inside the microdischarge filaments energetic electrons can excite rare gas (RG) atoms which, under appropriate conditions, react to form RG/RG dimers or RG/halogen dimers. With the pure RG dimers Ar<sub>2</sub><sup>\*</sup>, Kr<sub>2</sub><sup>\*</sup>, Xe<sub>2</sub><sup>\*</sup>, their chlorides ArCl<sup>\*</sup>, KrCl<sup>\*</sup>, XeCl<sup>\*</sup> and their fluorides ArF<sup>\*</sup>, KrF<sup>\*</sup>, XeF<sup>\*</sup> a number of narrow-band UV sources can be obtained in the wavelength region between 120 nm and 360 nm. The physical parameters of the microdischarges and the reaction kinetics of excimer formation in silent discharges are discussed. The potential of these new UV sources for industrial UV processing is demonstrated. As an example of an application for such incoherent excimer UV sources structured and large-area metal deposition induced by the 172 nm radiation from a silent discharge in xenon is shown. Patterned thin palladium films could be produced by irradiating a palladium acetate coating through a contact mask. In a second step thicker copper layers were deposited on top of the palladium patterns by an electroless plating process.

### INTRODUCTION

Energetic UV photons can initiate a variety of chemical, physical or biological processes. Some examples are photochemical synthesis and degradation, the UV initiated polymerization of coatings and paints, the UV induced deposition of metals and dielectrics and the disinfection of drinking water. For the industrial application of such processes UV sources of high intensity are required. In most cases the UV spectrum of the source will have to be matched to the intended process. Intense UV radiation is commercially available from medium and high pressure arc discharges in xenon and mercury / rare gas mixtures. These discharges emit a broad spectrum ranging from about 200 nm to the near infrared. For many desired processes selective UV radiation of certain wavelengths is required. Apart from UV lasers only few sources and wavelengths are available. By far the most important UV source is the low pressure glow discharge in mercury / rare gas mixtures emitting the Hg resonance lines at 254 nm and possibly also at 185 nm. Much lower photon fluxes can be obtained from low pressure rare gas resonance line sources, e.g. the krypton line at 124 nm and the xenon line at 147 nm. These VUV sources are mainly used as wavelength and intensity standards. Also the two VUV standards for continuum radiation the deuterium lamp and the argon miniarc, due to their moderate photon fluxes, are mainly used as laboratory tools.

The utilization of excimer radiation from gas discharges provides a new approach for the generation of high-intensity narrow-band UV radiation (ref. 1,2). Excimers (**excited dimers, trimers**) are unstable excited molecular complexes of molecules that under normal conditions do not possess a stable ground state and thus are not known from classical chemistry. Under the influence of short wavelength irradiation or energetic particle bombardment excimers can form in many different gases and vapours. One of the most striking properties of these excimer complexes is that they disintegrate typically within less than a microsecond and, during their decay, give off their binding energy in the form of UV or VUV radiation. So far, the most important technical devices using excimer radiation are the excimer lasers. Commercial excimer lasers are pumped by pulsed gas discharges (ref. 3). Most investigations into excimer kinetics are based on the excitation of different gas mixtures by high energy electron beams (ref. 4-6). Alternative ways of generating excimers rely on the excitation by VUV or synchrotron radiation (ref. 7-9), by protons (ref. 10), by  $\alpha$ -particles (ref. 11, 12), heavy ions (ref. 13) or even nuclear fragments (ref. 14, 15). In addition, different types of gas discharges reaching from DC glow discharges (ref. 16) over AC discharges (ref. 17), pulsed discharges (ref. 18) to microwave discharges (ref. 23-26) have successfully been used as sources of excimer radiation. An interesting discharge which holds great promise for large-scale industrial generation of excimer UV radiation is the silent discharge. Its potential for high-intensity generation of UV and VUV radiation has evolved only in recent years.

### SILENT DISCHARGE CHARACTERISTICS

Tanaka was probably the first to realize that rare gas excimers can form in silent discharges (ref. 27). Other investigations into the rare gas excimer continua in silent discharges were reported by Volkova et al. (ref. 28) and by Xu (ref. 29). While these experiments were mainly oriented towards providing miniature light sources for spectroscopic purposes newer investigations (ref. 1,2) show the possibility to build large-area high-intensity UV sources for industrial processing.

The silent discharge is a non-equilibrium discharge which can be operated up to pressures of several bar. It is industrially used on a large scale for the generation of ozone from air or oxygen (ref. 30). Ozone generators have a typical power consumption ranging from some kilowatts to several megawatts. The main characteristic of the silent discharge is that narrow discharge gaps of a few millimetre spacing are used and that at least one of the electrodes is covered by an insulating layer. For this reason the silent discharge is also referred to as the "dielectric-barrier discharge" or simply as the "barrier discharge". Based on its most important application the term "ozonizer discharge" can be found in the literature as well. Fig. 1 shows such a discharge configuration which can be filled with different gas mixtures. The base plate is made from stainless steel and can be cooled with water coming from a thermostat. The dielectric plate was made from high purity quartz (suprasil 1) and had a diameter of 100 mm and a thickness of 3 mm. The UV radiation generated in the discharge gap between the quartz plate and the steel plate can exit through a wire mesh high voltage electrode mounted in a metal ring. For gap spacings of a few millimetres and filling pressures ranging from 0.1 to 1.5 bar a sinusoidal feeding voltage of a few kV amplitude was adequate to run the discharge. Frequencies from 50 Hz to several MHz were used.

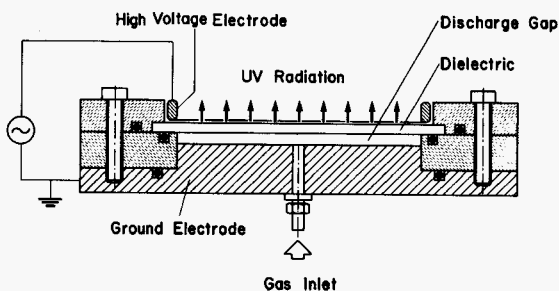

Fig. 1. Planar excimer UV source

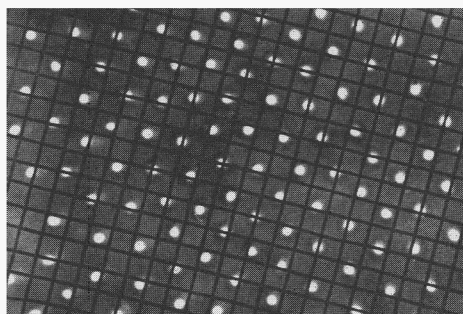

Fig. 2. Photograph of microdischarges in xenon. Original Size: 26 mm × 38 mm

The presence of the dielectric has a decisive influence on the discharge development. The current flow in the discharge is brought about by a large number of randomly distributed microdischarges. These microdischarge filaments are of submicrosecond duration and submillimetre radial extension. At the dielectric the thin current filaments spread into the discharge gap. The properties of these microdischarges were extensively studied and theoretically described in connection with ozone generation (ref. 31). The plasma conditions in the microdischarges are ideal for non-equilibrium plasma chemistry. The electron energy can be influenced by the gap spacing and the filling pressure. It is typically in the range 1-20 eV, ideally suited for the excitation, dissociation or ionization of atomic or molecular species. The electron energy in a discharge is, above all, a function of the reduced electric field ( $E/n$ ) i.e. the electric field divided by the particle density. At ignition of the discharge the lowest possible value for the reduced field is given by the Paschen curve which represents the ignition criterion for stationary breakdown in a homogeneous electric field. In reality the effective reduced field at the current maximum of an individual microdischarge can be noticeably higher. First of all, considerable time delays before breakdown are observed in narrow discharge gaps supplied by an alternating voltage. Secondly, during breakdown the eigenfield due to space charge accumulation at the propagating streamer head can lead to high local fields (ref. 32). Fig. 3 shows schematically the connection between the product  $nd$  (particle density  $\times$  gap spacing), the reduced field  $E/n$  and the mean electron energy in xenon. The effective breakdown field was assumed to be 50% higher than the Paschen field for stationary breakdown. Clearly, by changing  $nd$  one can influence and optimize the electron energy. In this respect the silent discharge provides more flexibility than other gas discharges. This could be demonstrated by looking at the intensity ratio of the mercury resonance lines. While in a glow discharge  $I(185\text{ nm}) / I(254\text{ nm})$  is always close to 0.2 in a silent discharge it could be varied between 0.1 and 3 (ref. 33).

The amount of charge that is transported in an individual microdischarge can be influenced by the thickness and the dielectric constant of the dielectric barrier(s). Thus, also the electron density in the microdischarge channels can be influenced. Typical current densities in the microdischarge filaments are of the order of 100-1000 A/cm<sup>2</sup> and typical electron densities are in the range of 10<sup>14</sup> - 10<sup>15</sup> cm<sup>-3</sup>. These parameters are close to the discharge parameters of excimer lasers. For this reason silent discharges can also be used for the efficient generation of incoherent excimer UV radiation.

In addition to the plane geometry shown in Fig. 1 we also used cylindrical geometries with annular discharge gaps (Fig. 4). The cylindrical discharge tube has the advantage that less O-ring seals are required and that sealed off quartz versions are conceivable. This way all metal parts can be kept outside the quartz envelope. The plane unit, on the other hand, has the advantage that short-wavelength VUV radiation that will not pass through quartz can be transmitted by dielectric barriers of lithium fluoride, calcium fluoride or magnesium fluoride.

Fig. 3. Connection between the product  $nd$ , the reduced electrical field  $E/n$  and the mean electron energy in xenon (1 Townsend (Td)  $\triangleq 10^{-17}$  V cm<sup>2</sup>)

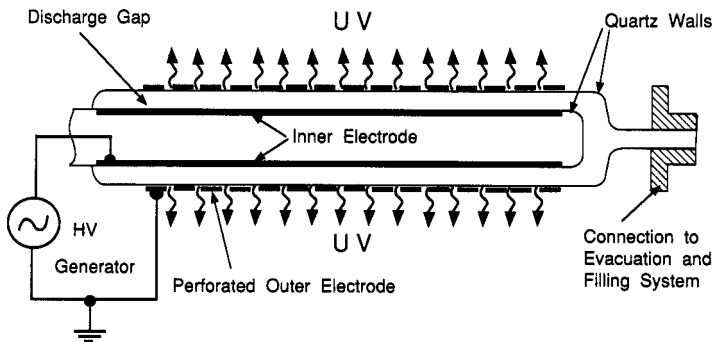
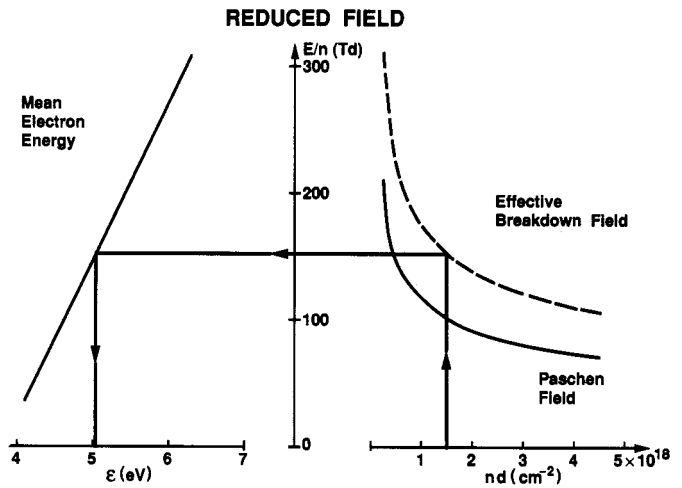
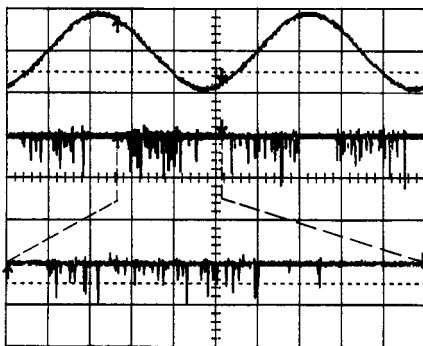

Fig. 4. Cylindrical excimer UV source with annular discharge gap

A few remarks should be added about the temporal aspects of the light emission. If a sinusoidal driving voltage is applied (Fig. 5) bursts of UV pulses are emitted with twice the frequency of the driving source. Between these bursts there are pauses with no discharge activity. Since the emission originates from randomly distributed microdischarges an irregular number of short UV flashes are observed within one burst (lower trace). In xenon the duration of individual light pulses was determined to be about 5ns (Fig. 6).



$f = 2 \text{ kHz}$

Fig. 5. Oscillogram of feeding voltage (upper trace) and photomultiplier output ( $\lambda = 172 \text{ nm}$ ). The lower trace is expanded by a factor of 4

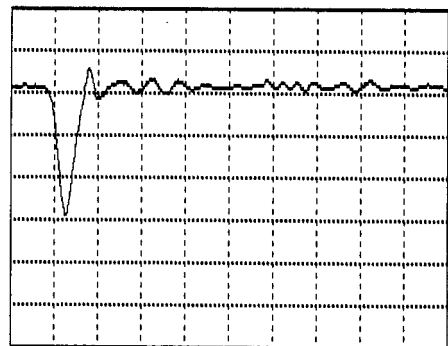

Time: 10ns / div

Fig. 6. Individual UV pulse at 172 nm

### PURE RARE GAS EXCIMERS

Excited dimers of argon, krypton and xenon emit narrow-band VUV radiation between 100 and 200 nm. From electron beam experiments it is known that these pure rare gas excimers are efficient fluorescers converting about 50% of the electron energy into VUV radiation (ref. 6). As a matter of fact the first excimer laser built by Basov (ref. 34) in 1970 operated on pure xenon. We also focussed our attention on xenon because its second continuum can be extracted through a high purity quartz envelope. Xenon has a slightly bound excimer state at about 8 eV (Fig. 7). The spontaneous emission resulting from a transition to the repulsive ground state peaks around 7.2 eV or 172 nm. In the microdischarges the electron energy has to be optimized for efficient excitation of the  $\text{Xe}^*$  level which can react to form the  $\text{Xe}_2^*$  excimer.



Since excimer formation is a three body reaction higher pressures favour excimer formation. For this reason non-equilibrium discharges at pressures above 50 mbar are required. In addition to the direct path of reactions (1a) and (2) the  $\text{Xe}_2^*$  state is populated by reactions starting from higher lying excited and ionic atomic and molecular states. Extended kinetic models treating the interaction of high-energy electron beams with xenon are given in ref. 35-37. Most models are based on the assumption that the various excited states of the xenon atom and molecule can be represented by two (fictitious) excited atomic and molecular states:  $\text{Xe}^*$ ,  $\text{Xe}^{**}$ ,  $\text{Xe}_2^*$ ,  $\text{Xe}_2^{**}$  (Fig. 8). The application of such models to silent discharges is treated in ref. 1, 2, 38-40. For silent discharges an intrinsic UV efficiency of about 40% is predicted. Considering the solid angle of the radiation leaving the discharge and the transmission of quartz and the mesh electrode this is in agreement with the experimentally determined efficiencies of about 5-10% (ref. 41). Thus, silent discharges in xenon can be powerful sources of VUV radiation peaking at 172nm, having a half-width of 12-14 nm and emitting practically no other radiation in the wavelength region between 100 and 800 nm (Fig. 9). Thus, for purposes of photochemistry, this is a VUV source of high spectral purity.

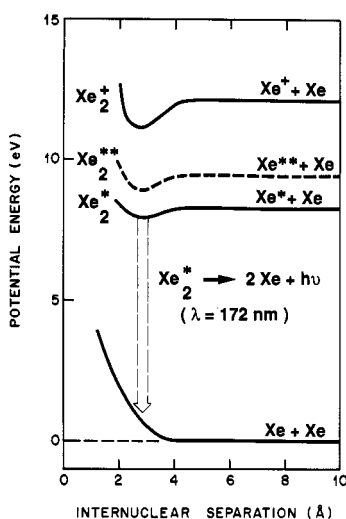

Fig. 7. Simplified potential energy diagram of xenon

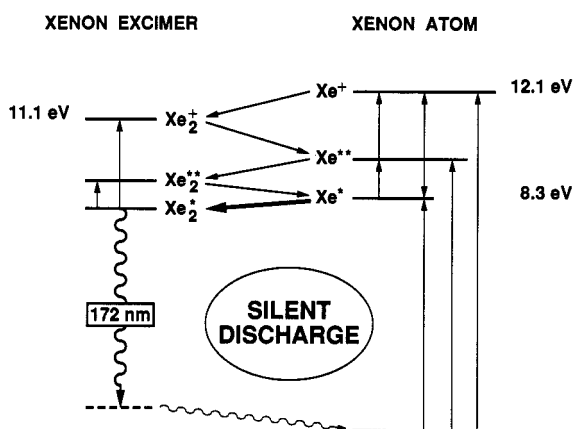

Fig. 8. Simplified reaction scheme of a silent discharge in xenon

In a similar way the excited dimers of argon and krypton could be generated in silent discharges. Their continua peak at 128 nm and 148 nm respectively (Fig. 10). (The emission spectra given in this paper are not corrected for detector response and window transmission. All intensities are given in arbitrary units on a linear scale).

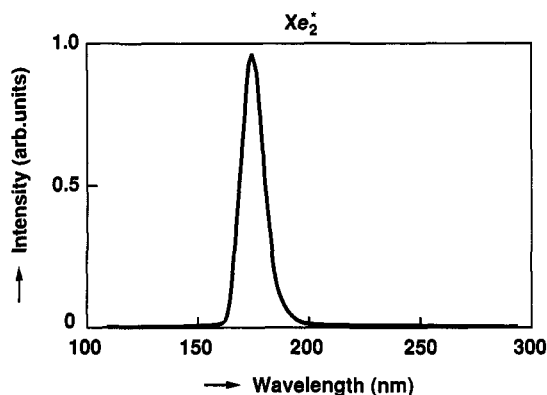

Fig. 9. Spectrum of xenon excimer radiation from a silent discharge

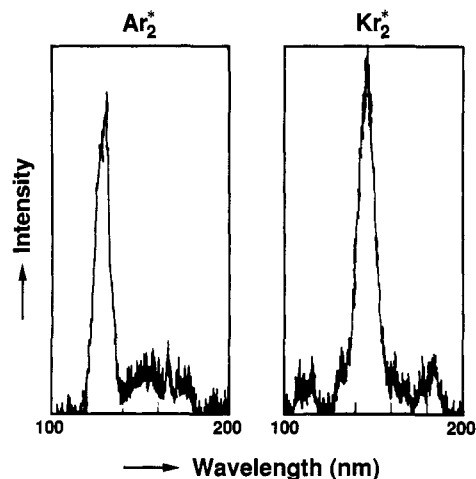
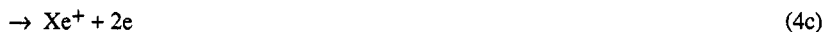

Fig. 10. Spectra of argon and krypton excimer radiation from a silent discharge

### RARE GAS HALIDE EXCIMERS

In addition to the pure rare gas excimers the rare gas chlorides and fluorides can be generated in silent discharges. In a mixture of xenon and chlorine (ref. 1,2,33) strong radiation at 308 nm resulting from the B→X transition of the XeCl\* excimer can be observed. In the microdischarges the xenon atoms are excited and ionized while, at the same time, the Cl<sub>2</sub> molecule is split by a dissociative attachment reaction



The symbol (v) indicates that vibrationally excited states of the chlorine molecule may have an important influence on the reaction kinetics. In the rare gas / halogen mixtures ion recombination is an important reaction path resulting in excimer formation.



where M stands for a third collision partner which is normally one of the buffer gases argon, helium or neon. In most gas discharges excimer formation by harpooning reactions such as



is of minor importance. The buffer gases can be used to influence the electron energy distribution and to introduce additional reaction paths. In a mixture of argon, xenon and chlorine, for example, the following fast excimer reaction is important



Another incentive to use buffer gases is, of course, the cost of the different rare gases. In XeCl lasers hydrogen chloride is used instead of chlorine. Ref. 42 showed that such mixtures will also lead to XeCl\* excimer radiation in silent discharges.

Our Experiments were carried out with chlorine addition. Fig. 11 shows the three chloride spectra of argon, krypton and xenon providing intense narrow band radiation at 175, 222 and 308 nm respectively. Interestingly enough, the half-width of 2-4 nm (ref. 33) is considerably smaller than that of the pure rare gas excimer continua. We also succeeded in obtaining the rare gas fluoride spectra ArF\* at 193 nm, KrF\* at 248 nm and XeF\* at 352 nm (Fig. 12). For these experiments we used traces of SF<sub>6</sub> as a fluorine donor.

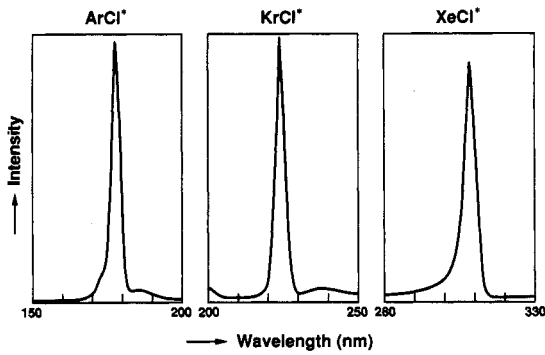

Fig. 11. Rare gas chloride excimer radiation

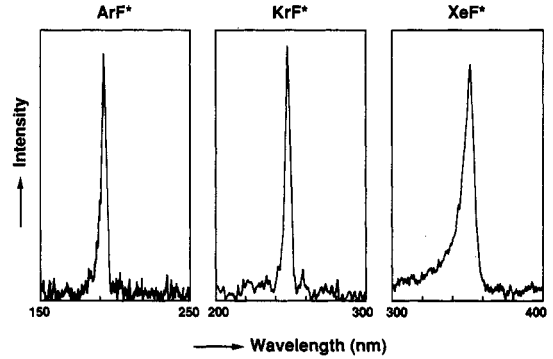
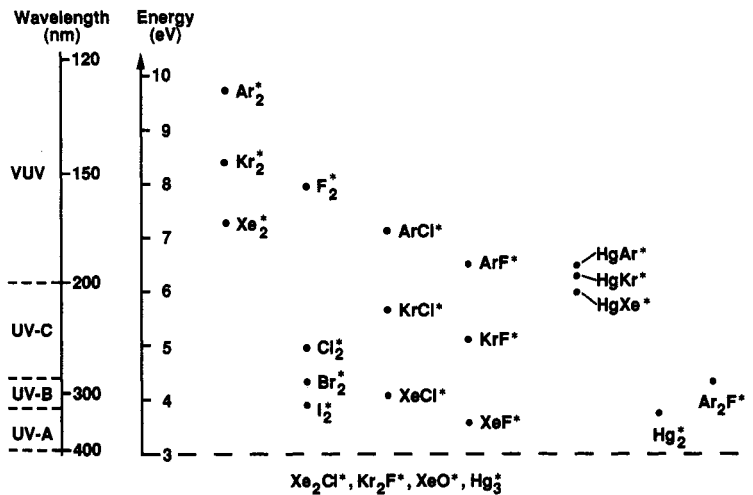

Fig. 12. Rare gas fluoride excimer radiation

From this experience we conclude that most likely any known excimer can be generated in silent discharges if the gas mixtures and plasma conditions are properly adjusted. The selection of potential excimer sources presented in Fig. 13 demonstrates that a wide choice of UV and visible wavelengths is available.

Fig. 13. Selection of potential excimer sources



**FUTURE TRENDS IN UV GENERATION**

A major advantage of the silent discharge is its flexibility with respect to the geometrical shape of the discharge volume. As Fig. 14 shows we can adapt the form of the UV source to the intended process in a manner which is unprecedented in UV generation. In addition to forming plane panels for the irradiation of large surfaces and volumes, cylindrical sources radiating outwards or even radiating inwards can be built. This last geometry has a great potential for irradiating fibre surfaces or gas and liquid flows.

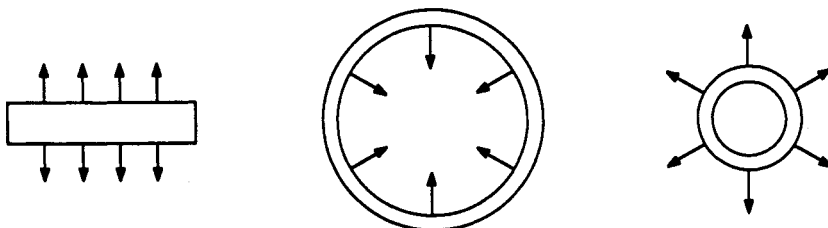

Fig. 14. Different geometries for silent discharge excimer sources

As far as industrial applications are concerned the silent discharge can be scaled up to large surface areas and large power levels. The power going into a silent discharge can be increased by raising the voltage and by raising the frequency. To a first approximation the plasma parameters in the individual microdischarges do not change. Higher power just means more microdischarges per unit electrode area and per unit time. The narrow-band emission spectra indicate that it is possible to find gas mixtures and discharge conditions in which one reaction path dominates. For the extraction of the UV radiation from the discharge volume a major advantage of using excimers is the absence of a stable ground state. As a consequence, there is no danger of radiation trapping in the discharge plasma and in colder boundary layers.

### APPLICATIONS OF UV RADIATION

As mentioned in the introduction UV radiation can cause biological, chemical and physical changes. A well established biological effect is disinfection with UV radiation. It is used for water purification and the sterilization of surfaces. For this purpose UV-C radiation of 240-280 nm wavelength is ideally suited to prevent duplication of nucleic acids and hence the reproduction of microorganisms (ref. 43). The capability of energetic UV radiation to break chemical bonds has found many applications in photochemical synthesis and degradation. UV induced initiation of free radical reactions in photopolymerization (UV curing) has already grown into a multi-billion dollar business (ref. 44). In addition to the curing of coatings, paints, adhesives and plastics new applications are evolving in the UV curing of insulating and conductive layers on printed circuit boards (ref. 45). UV processes can also be used for surface modification or even micromachining either by bond-breaking or by reactive etching and oxidation. Such processes can easily be initiated by photolysis of  $\text{Cl}_2$ ,  $\text{F}_2$ ,  $\text{O}_2$  or  $\text{O}_3$ . With vacuum UV radiation chemical reaction chains can be started by the photodissociation of silane or disilane or the splitting of a very reactive  $\text{O}(^1\text{D})$  atom from  $\text{O}_2$ ,  $\text{O}_3$  or  $\text{N}_2\text{O}$ . A fast growing area is the photodissociation of organometallics. For the production of printed circuit boards and microcircuits UV induced processes are being studied for the patterned deposition and removal of dielectric and metal layers. In other applications films of special mechanical, chemical, optical or even magnetic properties are deposited

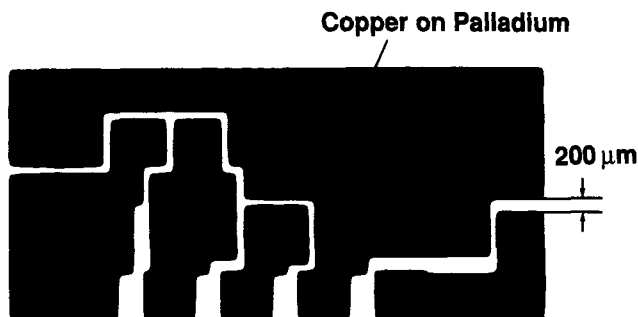

Fig. 15. Example for structured metal deposition with a silent discharge xenon excimer source

As an example metal deposition with a VUV silent discharge excimer source is shown (ref. 46). We used the 172 nm radiation of the  $\text{Xe}_2^*$  excimer to deposit palladium from a film of palladium (II) acetate dissolved in chloroform. With the aid of a contact mask structured palladium segments could be produced with good surface adhesion. This palladium nucleation of 5-50 nm thickness could be coated with copper by electroless plating to produce copper conductors of several micrometre thickness (Fig. 15).

In many of these applications UV processes compete with plasma processes. Also, combined processes like UV enhanced chemical vapour deposition or UV assisted plasma etching are being studied. The major advantages of UV processes are that they can be much more selective, that structuring requires little effort and that the substrate is neither exposed to high temperatures nor to charged particle bombardment.

These advantages caused an explosive growth of investigations into UV processes. Although, apart from UV curing and UV disinfection, industrial UV processing is still in its infancy a recent review on photochemical vapour deposition (ref. 47) listed already 87 references. So far, progress has been slowed down by the restricted availability of light sources with high photon fluxes in the UV and especially in the vacuum UV range. It is therefore foreseeable that wavelength-selective excimer sources of high UV output and different geometries driven by silent discharges will find a number of interesting applications.

**Acknowledgement** Thanks are due to B. Eliasson, W. Egli, H. Esrom and B. Gellert who contributed to the work described in this article.

## REFERENCES

1. B. Eliasson, U. Kogelschatz and H.J. Stein, EPA Newslett. **32**, 29-40 (1988) (Europ. Photochem. Ass).
2. B. Eliasson and U. Kogelschatz, Appl. Phys. B **46**, 299-303 (1988).
3. Ch.K. Rhodes, Excimer Lasers, Springer, Berlin (1979).
4. F. Collier and M. Michon, L'Onde Electr. **54**, 467-473 (1974).
5. H.A. Koehler, L.J. Ferderber, D.L. Redhead and P.J. Ebert, Phys. Rev. A **9**, 768-781 (1974).
6. C. Duzy and J. Boness, IEEE J. Quant. Electron. **QE-16**, 640-649 (1980).
7. R. Brodmann and G. Zimmerer, J. Phys. B: Atom Molec. Phys. **10**, 3395-3408 (1977).
8. O. Dutuit, R. A. Gutchek and J. Lecalvé Chem. Phys. Lett. **58**, 66-72 (1978).
9. V.S. Zuev, A.V. Kanaev and L.D. Mikheev, Sov. J. Quantum Electron **14**, 242-248 (1984).
10. T.E. Stewart, G.S. Hurst, T.E. Bortner, J.E. Parks, F.W. Martin and H.L. Weidner, J. Opt. Soc. Am. **60**, 1290-1297 (1970).
11. R. Bouciqué and P. Mortier, J. Phys. D: Appl. Phys. **3**, 1905-1911 (1970).
12. O. Cheshnovsky, B. Raz and J. Jortner, Chem. Phys. Lett. **15**, 475-479 (1972).
13. G. Ribitzki, Untersuchungen zum Bau von schwerionenstrahlgepumpten Edelgasexcimerlasern, Diplomarbeit, TU München (1986).
14. R.T. Schneider and F. Hohl, Nuclear Pumped Lasers, in Adv. Nucl. Sci. Technol. **16**, 123-287 (1984).
15. M.A. Prelas, F.P. Boody, G.H. Miley and J.F. Kunze, Laser Part. **6**, 25-62 (1988).
16. D. Lindau and H.F. Döbele, Rev. Sci. Instrum. **59**, 565-568 (1988).
17. A.K. Shuaibov and V.S. Shevera, Sov. Phys. Tech. Phys. **24**, 976-977 (1979) and **25**, 434-438 (1980).
18. R.E. Huffman, Y. Tanaka and J.C. Larrabee, Appl. Opt. **2**, 617-623 (1963).
19. R. Turner, Phys. Rev. **158**, 121-129 (1967).
20. T. Gerber, W. Luethy and P. Burkhardt, Opt. Comm. **35**, 242-244 (1980).
21. W. Wieme and J. Lenaerts, J. Chem. Phys. **74**, 483-493, (1981).
22. K. Kakizaki, Y. Sakai, H. Date and H. Tagashira, Proc. 9th Int. Conf. on Gas Discharges and their Applications, 713-716, Venice (1988).
23. Y. Tanaka and M. Zelikoff, J. Opt. Soc. Am. **44**, 254-255 (1954).
24. P.G. Wilkinson and E.T. Byram, Appl. Opt. **4**, 581-588 (1965).
25. A.R. Calloway, T.A. Galantowicz and W.R. Fenner, J. Vac. Sci. Technol. A1, 534-536 (1983).
26. H. Kumagai and M. Obara, Appl. Phys. Lett. **54**, 2619-2621 (1989).
27. Y. Tanaka, J. Opt. Soc. Am. **45**, 710-713 (1955).
28. G.A. Volkova, N.N. Kirillova, E.N. Pavlovskaya and A.V. Yakovleva, J. Appl. Spectrosc. **41**, 1194-1197 (1984).
29. X. Xu, Proc. 8th Int. Conf. on Gas Discharges and their Applications, 580-583, Oxford (1985).
30. U. Kogelschatz, Advanced Ozone Generation in Process Technologies for Water Treatment, 87-120, S. Stucki, ed., Plenum, New York (1988).
31. B. Eliasson, M. Hirth and U. Kogelschatz, J. Phys. D: Appl. Phys. **20**, 1421-1437 (1987).
32. B. Eliasson and U. Kogelschatz, The Silent Discharge and its Applications to Ozone and Excimer Formation, Proc. NATO Advanced Study Institute on Non-Equilibrium Processes in Ionized Gases, Aquafredda di Maratea, Italy (1989).
33. B. Gellert, B. Eliasson and U. Kogelschatz, Proc. 5th Int. Symp. on Science & Technology of Light Sources, York (1989).
34. N.G. Basov, V.A. Danilychev and Yu.M. Popov, Sov. J. Quantum Electron. **1**, 18-22 (1971).
35. F. Kannari and W.D. Kimura, J. Appl. Phys. **63**, 4377-4387 (1987).
36. A.K. Chung and M.A. Prelas, Laser Part. **5**, 125-132 (1987).
37. D.J. Eckstrom, H.H. Nakano, D.C. Lorents, T. Rothem, J.A. Betts, M.E. Lainhart, D.A. Dakin and J.E. Maenchen, J. Appl. Phys. **64**, 1679-1690 (1988).
38. B. Eliasson and U. Kogelschatz, Proc. 9th Int. Conf. on Gas Discharges and their Applications, 709-712, Venice (1988).
39. H. Müller and M. Neiger, Proc. 41st Gaseous Electronics Conference, 55, Minneapolis (1988).
40. B. Eliasson and W. Egli, Proc. XIX Int. Conf. on Phenomena in Ionized Gases, 1024-1025, Belgrade (1989).
41. B. Eliasson and U. Kogelschatz, 2nd Int. Conf. on UV and Ozone in the Treatment of Water and Other Liquids (Wasser Berlin 1989), IV-6-1 - IV-6-11, Berlin (1989).
42. V. Schorpp, K. Stockwald and M. Neiger, Proc. 41st Gaseous Electronics Conference, 74, Minneapolis (1988).
43. C. von Sonntag, Disinfection with UV Radiation in Process Technologies for Water Treatment, 159-179, S. Stucki, ed., Plenum Press, New York (1988).
44. C. Decker, J. Coatings Technol. **59**, 97-106 (1987).
45. W.F.A. Su, J.D.B. Smith and A.H. Long, SAMPE J. **24**, 27-32 (1988).
46. H. Esrom, G. Wahl and U. Kogelschatz, Proc. 7th Europ. Conf. on Chemical Vapour Deposition, (Perpignan, France 1989), J. Phys. (France) **50**, C5-719 to C5-725 (1989).
47. R.L. Abber, Photochemical Vapor Deposition in Handbuch of Thin-Film Deposition Processes and Techniques, 270-290, K.K. Schuegraf, ed., Noyes Publications, Park Ridge, N.J. USA (1988).