

Long-distance charge transport through DNA. An extended hopping model*

Bernd Giese[†], Martin Spichty, and Stefan Wessely

Department of Chemistry, University of Basel, St. Johannis Ring 19, CH-4056
Basel, Switzerland

Abstract: Long-distance transfer of a positive charge through DNA can be described by a hopping model. In double strands where the (A:T)_n bridges between the guanines are short ($n \geq 3$), the charge hops only between guanines, and each hopping step depends strongly upon the guanine to guanine distances. In strands where the (A:T)_n sequences between the guanines are rather long ($n \geq 4$), also the adenines act as charge carriers. To predict the yields of the H₂O-trapping products one has to take into account not only the charge-transfer rates but also the rates of H₂O-trapping reactions.

In the 1990s, the question of long-distance electron transfer through DNA raised a controversial discussion [1]. We entered this area three years ago by studying radical-induced DNA strand cleavage reactions. Our experiments showed that photolysis of a 4'-acylated nucleoside in the DNA double strand **1** yields radical cation **2** that selectively oxidizes guanine (G) and forms a guanine radical cation (G^{•+}) in **3** (Fig. 1) [2].

This reaction sequence led to an assay that made it possible to follow the charge migration through DNA by trapping of the positive charge at the heterocyclic base [3]. In order to understand the experimental results, we suggested in 1998 a hopping mechanism [3] for long-distance charge transport through DNA, which is based on the theoretical model of Jortner [4]. A similar hopping mechanism, which is slightly different in the details, was also suggested by Schuster [5], and today there is a con-

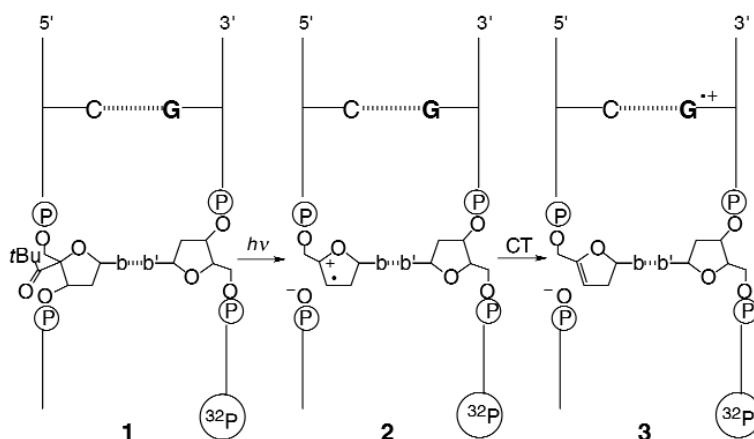

Fig. 1 Assay for the charge injection into a guanine (G).

*Lecture presented at the XVIIIth IUPAC Symposium on Photochemistry, Dresden, Germany, 22–27 July 2000. Other presentations are published in this issue, pp. 395–548.

[†]Corresponding author

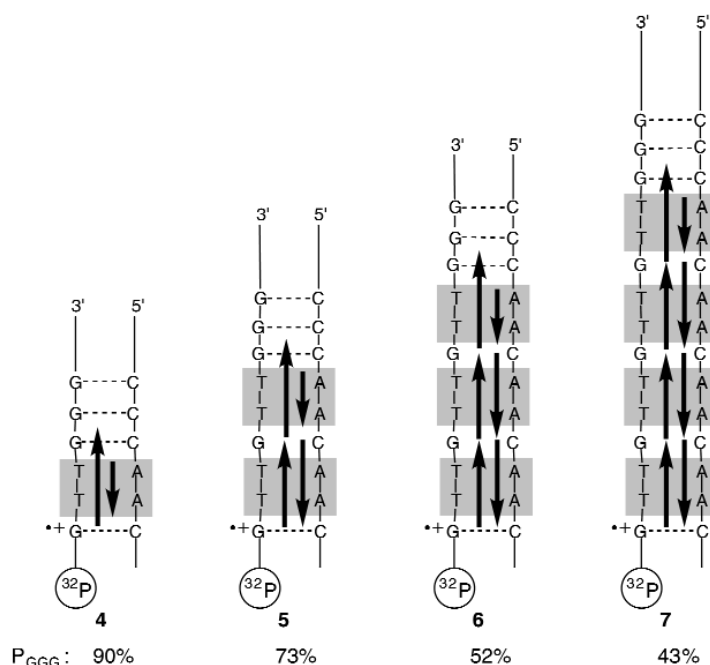

Fig. 2 Yield of H₂O-trapping products at the GGG sequence (P_{GGG}) in long-distance charge transfer by a hopping between guanines (G).

sensus that long-distance charge transport through DNA occurs by a multistep hopping process [6]. Out of the four natural heterocyclic bases guanine (G) has the lowest ionization potential [7], therefore G is the preferred carrier of the positive charge. Thus, in double strands 4–7 of Fig. 2 the positive charge hops between the guanines to the GGG unit, which has an even lower redox potential than a single G. Trapping of the guanosine radical cation ($G^{\bullet+}$) leads to products P_G and P_{GGG} that are separated and analyzed quantitatively by gel electrophoresis.

This hopping model implies that the electron transfer from a G to a $G^{\bullet+}$ is faster than the trapping reaction by H₂O so that the charge should be partly distributed over the guanines before it is trapped [8]. Therefore, the yields of products P_G decrease only slightly from P_{G1} to P_{G4} , although the distance to the charge donor $G_1^{\bullet+}$ increases by 10 Å per each hopping step (Fig. 3).

This slow decrease of the product yields must not be mixed up with a weak distance influence on the charge-transfer rate. It is the ratio between the charge transfer and the H₂O-trapping rates that governs the product ratios (Fig. 4). We have quantitatively described this situation using the Curtin–Hammett principle [10]. The product ratio decreases only slightly as long as the H₂O reaction is slower than the charge-transfer steps.

Figure 5 shows how the charge migration from G_1 via G_2 , G_3 , G_4 to the GGG unit precedes the product formation.

Despite this weak distance influence on the product formation, the influence of the distance on the charge-transfer rate k_{CT} of each hopping step is large, and the β -value is about 0.7 \AA^{-1} (Fig. 6) [3,9].

Thus, the electron-transfer rate between $G^{\bullet+}$ and G over an (A:T)_{*n*} bridge dramatically decreases with *n* until one reaches the situation in which the endothermic oxidation of the adjoining adenine (A) by $G^{\bullet+}$ is as fast as the oxidation of a distant G [10]. Using a buffer at pH = 7, this seems to be the case if the number of A:T base pairs *n* of the (A:T)_{*n*} bridge is larger than 3 where the charge-transfer rate between the guanines is smaller than 10^5 s^{-1} . As shown in Fig. 7, in these strands also adenines (A) become charge carriers [10]. Once A is oxidized, the charge migrates in fast hopping steps between the

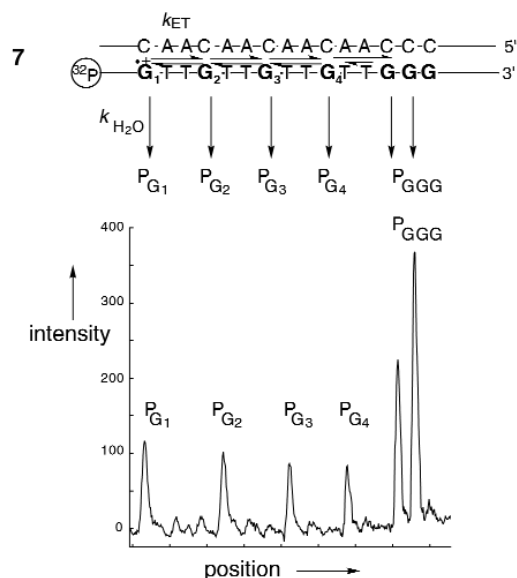

Fig. 3 Product yields P_G and P_{GGG} formed by trapping of the guanine radical cation ($G^{+\bullet}$) by H_2O during charge transfer through DNA double strand 7. The positive charge is injected into G_1 and migrates via G_2 , G_3 , and G_4 to the GGG unit.

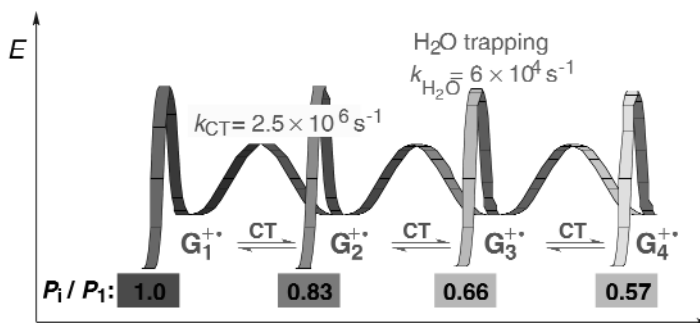

Fig. 4 Reaction profile diagram for the charge transfer and H_2O -trapping of the guanines G_1 to G_4 of double strand 7 at pH = 7.

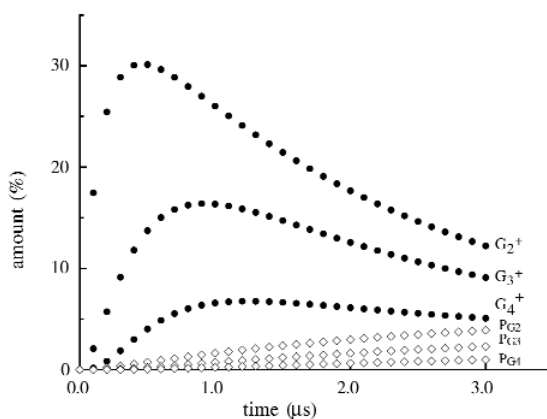

Fig. 5 Calculated charges at $G_2^{+\bullet}$, $G_3^{+\bullet}$, $G_4^{+\bullet}$ (\bullet), and H_2O -trapping products P_{G_2} , P_{G_3} , and P_{G_4} (\diamond) at the positions G_2 , G_3 , and G_4 , respectively, during charge transfer through double strand 7 at pH = 7.

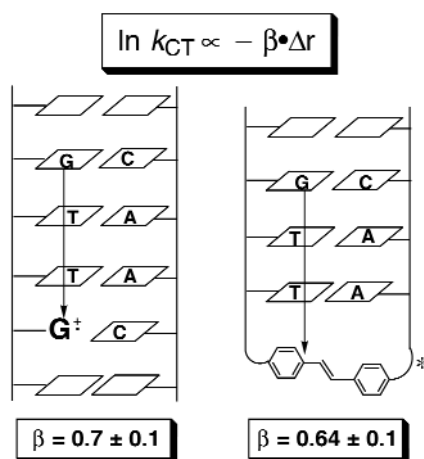

Fig. 6 Experimentally determined β -values using the assays of Giese [3] or Lewis and Wasielewski [9].

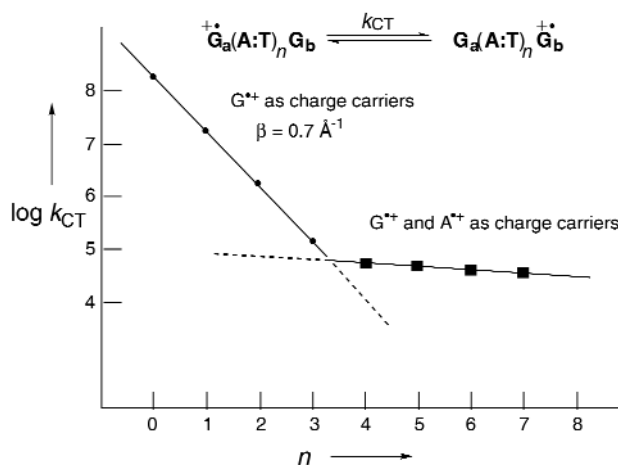

Fig. 7 Dependence of the charge-transfer rate on the number n of A:T base pairs between G_a and G_b in DNA double strands at pH = 7.

adjoining adenines until it reaches a G, so that the overall charge-transfer rate decreases only slowly with a further elongation of the $(A:T)_n$ bridge.

In conclusion, the yields of the trapping products P_G depend not only upon the charge transfer but also on the H_2O -trapping rates. In DNA double strands, where the H_2O -trapping reaction is very slow and the number of adjoining A:T base pairs is large, guanines and adenines are the carriers of the positive charge, and only a small distance influence on the ratios of products P_G will be observed. However, if the H_2O -trapping rate is very fast and the number of adjoining A:T base pairs is small into G, only guanines can act as the charge carriers, and the distance influence on the product ratios will be large. In between these two extremes, a complex situation arises. According to the Curtin–Hammett principle, the product ratios can be predicted using the known charge transfer rate constants [11], a β -value of 0.7 \AA^{-1} , and a kinetic model that treats the long-range charge transfer by a hopping mechanism between the guanines for short A:T sequences, or guanines and adenines for long A:T sequences [10].

ACKNOWLEDGMENTS

This work was supported by the Swiss National Science Foundation and the Volkswagen Foundation.

REFERENCES

1. Commentaries on hole transfer in DNA: a) E. K. Wilson. *Chem. Eng. News* **77**(34), 43 (1999); b) M. Ratner. *Nature* **397**, 480 (1999); c) M. W. Grinstaff. *Angew. Chem. Int. Ed.* **38**, 3629 (1999).
2. E. Meggers, D. Kusch, M. Spichty, U. Wille, B. Giese. *Angew. Chem. Int. Ed.* **37**, 459 (1998); E. Meggers, A. Dussy, T. Schäfer, B. Giese. *Chem. Eur. J.* **6**, 485 (2000).
3. E. Meggers, M. E. Michel-Beyerle, B. Giese. *J. Am. Chem. Soc.* **120**, 12950 (1998).
4. a) J. Jortner, M. Bixon, T. Langenbacher, M. E. Michel-Beyerle. *Proc. Natl. Acad. Sci. USA* **95**, 12759 (1998); b) B. Giese, S. Wessely, M. Spormann, U. Lindemann, E. Meggers, M. E. Michel-Beyerle. *Angew. Chem. Int. Ed.* **38**, 996 (1999); c) M. Bixon, B. Giese, S. Wessely, T. Langenbacher, M. E. Michel-Beyerle, J. Jortner. *Proc. Natl. Acad. Sci. USA* **96**, 11713 (1999).
5. P. T. Henderson, D. Jones, G. Hampikian, Y. Kan, G. B. Schuster. *Proc. Natl. Acad. Sci. USA* **96**, 8353 (1999).
6. B. Giese. *Acc. Chem. Res.* **33**, 631 (2000); G. B. Schuster. *Acc. Chem. Res.* **33**, 253 (2000); C. Wan, T. Fiebig, O. Schiemann, J. K. Barton, A. Zewail. *Proc. Natl. Acad. Sci. USA* **97**, 14053 (2000).
7. S. Steenken and S. V. Jovanovic. *J. Am. Chem. Soc.* **119**, 617 (1997).
8. B. Giese and S. Wessely. *Angew. Chem. Int. Ed.* **39**, 3490 (2000).
9. F. D. Lewis, T. Wu, Y. Zhang, R. L. Letsinger, S. R. Greenfield, M. R. Wasielewski. *Science* **277**, 673 (1997).
10. B. Giese and M. Spichty. *Chem. Phys. Chem.* **1**, 185 (2000).
11. F. D. Lewis, X. Liu, J. Liu, S. E. Miller, R. T. Hayes, M. R. Wasielewski. *Nature* **406**, 51 (2000).