

P-25 Fused and bridged fused systems

- P-25.0 Introduction
- P-25.1 Names of hydrocarbon components
- P-25.2 Names of heterocyclic components
- P-25.3 Constructing fusion names
- P-25.4 Bridged fused systems
- P-25.5 Limitations to fusion nomenclature: three components *ortho*- and *peri*-fused together
- P-25.6 Heteroatoms in nonstandard valence states
- P-25.7 Treatment of double bonds and δ -convention
- P-25.8 List of fusion components in decreasing order of seniority

P-25.0 Introduction

This section is based on the document entitled 'Nomenclature of Fused and Bridged Fused Ring System, IUPAC Recommendations 1998' (ref. 4).

In nomenclature, fusion is the operation that creates a common bond between two rings, each ring contributing one bond and the two atoms directly attached to the bond. This type of fusion is called *ortho*- or *ortho*- and *peri*-fusion if two adjacent bonds are involved. The term fusion is also used to describe the operation creating a common atom between two ring systems, each contributing one atom. This type of fusion is called spirofusion (see P-24.1). Traditionally, *ortho*- and *ortho*- and *peri*-fusion were simply called fusion and the resulting polycyclic systems were referred to as fused ring systems or fused ring compounds. The term 'spirofusion' is new in nomenclature, and to avoid ambiguity 'fusion' should not be used without the prefix 'spiro' when 'spirofusion' is intended."

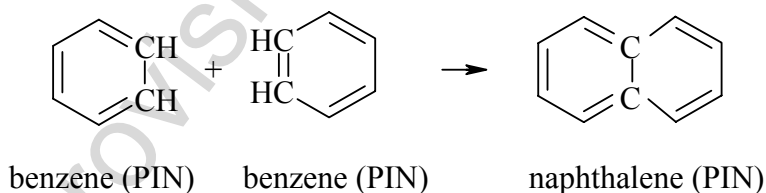

[naphthalene results from the fusion (*ortho*-fusion) of two benzene rings (one bond and two atoms in common)]

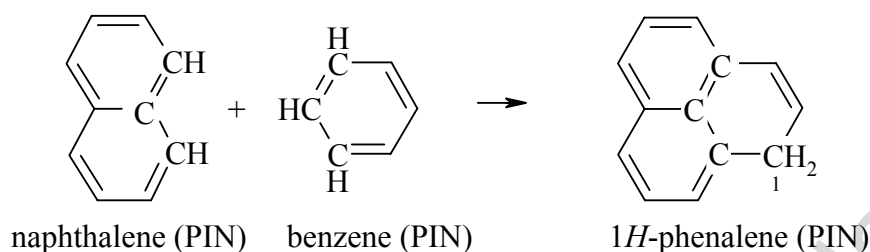

[1*H*-phenalene results from the fusion (*ortho*- and *peri*-fusion) of a naphthalene ring system and a benzene ring (two bonds and three atoms in common)]

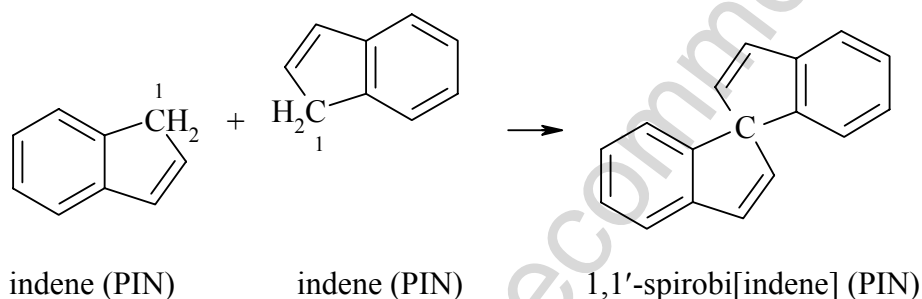

[spiro[biindene] results from the spirofusion of two indene ring systems (one atom in common)]

This section deals with fused (*ortho*- and *ortho*- and *peri*-fused) ring systems and bridged fused (*ortho*- and *ortho*- and *peri*-fused) ring systems. Spirofusion is described in Section P-24. This section is intended only as an introduction to the vast field of fusion nomenclature discussed in the document entitled 'Nomenclature of Fused and Bridge Fused Ring Systems' (ref. 4). The principles presented herein use rather simple examples; for more complex ring systems the publication noted above or the '*Ring Systems Handbook*', published by the Chemical Abstracts Service (ref. 16), should be consulted. Changes from previous rules are highlighted.

P-25.1 Names of hydrocarbon parent compounds are divided into two categories.

P-25.1.1 Retained names used for parent components and as attached components

P-25.1.2 Names formed systematically using endings and prefixes used for parent components and as attached components

P-25.1.1 Retained names for hydrocarbons (also called trivial names) used for parent components and for attached components

Retained names for polycyclic hydrocarbons are listed in Table 2.7, in decreasing order of seniority for being chosen as parent components in fusion nomenclature. Their numbering is indicated as the result of the application of the specific criteria used to number fused ring systems described in Section P-25.3.3.

Table 2.7 Retained names of hydrocarbon parent components in descending order of seniority (the seniority order is indicated by the number preceding the name; the lower the number the higher the seniority)

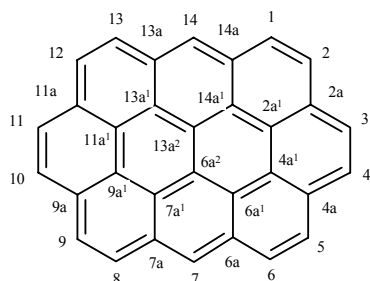

(1) ovalene (PIN)

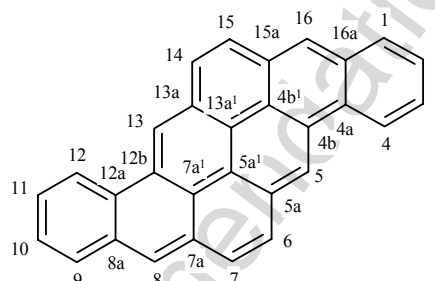

(2) pyranthrene (PIN)

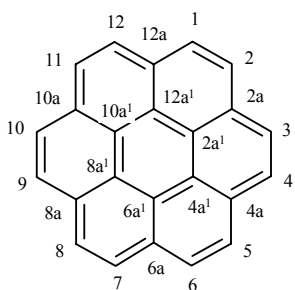

(3) coronene (PIN)

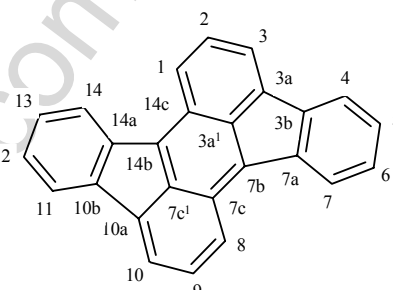

(4) rubicene (PIN)

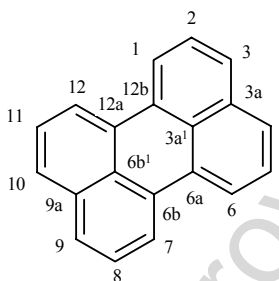

(5) perylene (PIN)

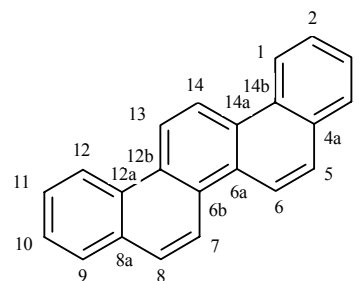

(6) picene (PIN)

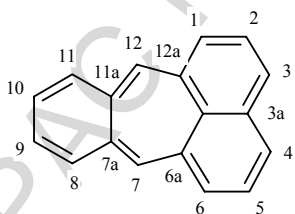

(7) pleiadene (PIN)

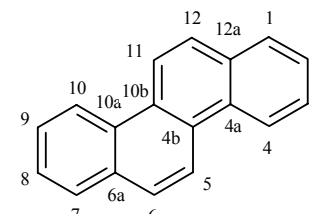

(8) chrysene (PIN)

Table 2.5 (cont'd.)

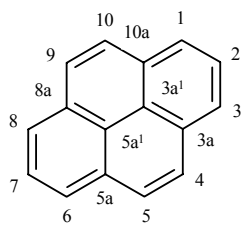

(9) pyrene (PIN)

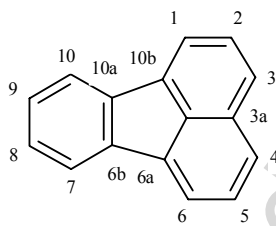

(10) fluoranthene (PIN)

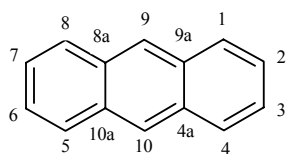

(11) anthracene (PIN)
(special numbering)

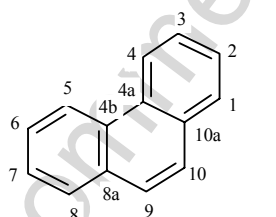

(12) phenanthrene (PIN)
(special numbering)

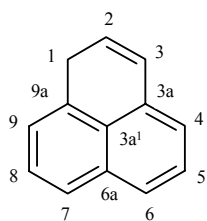

(13) phenalene (PIN)
(1*H*-isomer shown)

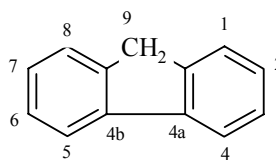

(14) fluorene (PIN)
(9*H*-isomer shown)

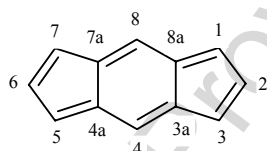

(15) *s*-indacene (PIN)

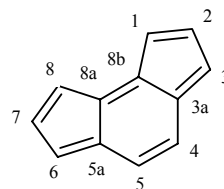

(16) *as*-indacene (PIN)

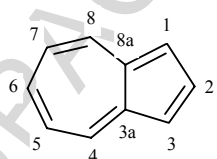

(17) azulene (PIN)

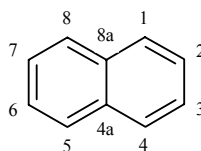

(18) naphthalene (PIN)

Table 2.5 (cont'd.)

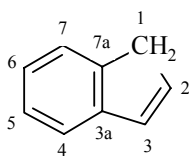

(19) indene (PIN)
(1*H*-isomer shown)

P-25.1.2 Systematically named hydrocarbon parent components

Names for some hydrocarbon parent components, having the maximum number of noncumulated double bonds and having at least two rings of five or more ring members are systematically formed using a prefix and an ending or term representing the nature and arrangement of the component rings. Rules for numbering are described in Section P-25.3.3.

- P-25.1.2.1 Polyacenes
- P-25.1.2.2 Polyaphenes
- P-25.1.2.3 Polyalenes
- P-25.1.2.4 Polyphenylenes
- P-25.1.2.5 Polynaphthylenes
- P-25.1.2.6 Polyhelicenes
- P-25.1.2.7 Ace...ylenes

P-25.1.2.1 Polyacenes. A hydrocarbon parent component consisting of four or more *ortho*-fused benzene rings in a straight linear arrangement is named by citing a numerical prefix ('tetra', 'penta', etc.) denoting the number of rings followed by the ending 'acene' (derived from the retained name anthracene) with elision of a letter 'a'.

Examples:

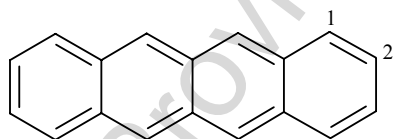

tetracene (PIN)
(formerly naphthacene)

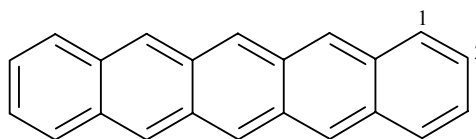

pentacene (PIN)

P-25.1.2.2 Polyaphenes. A hydrocarbon parent component consisting of n *ortho*-fused benzene rings ($n > 3$) forming two straight linear arrangements of $(n + 1)/2$ rings (if n is odd) or $n/2$ and $(n/2) + 1$ rings (if n is even) with a common benzene ring and that make a formal angle of 120° with each other is named by citing the numerical prefix ('tetra', 'penta', etc.) denoting the total number of benzene rings followed by the ending 'phene' (derived from **phenanthrene**).

Example:

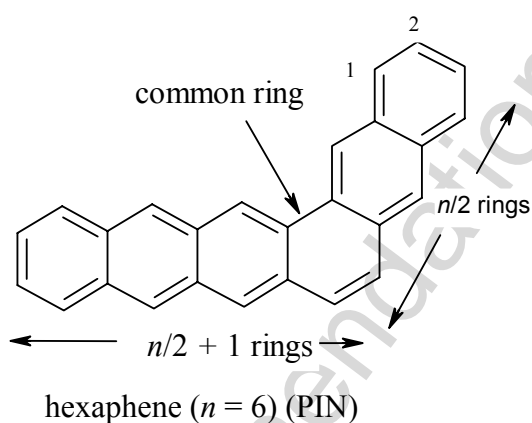
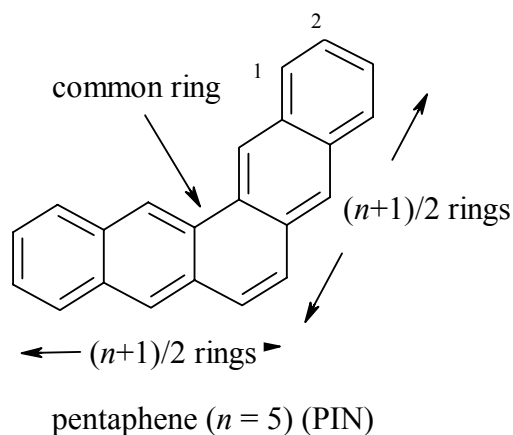

P-25.1.2.3 Polyalenes. A hydrocarbon parent component consisting of two identical *ortho*-fused monocyclic hydrocarbon rings is named by citing the numerical prefix ('penta', 'hepta', etc.) that denotes the number of carbon atoms in each ring followed by the ending 'alene' (derived from naphthalene) with elision of a letter 'a'. The name naphthalene is retained.

Examples:

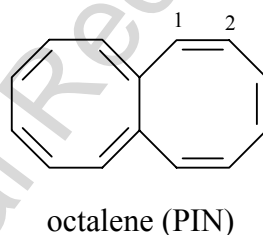
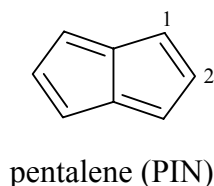

P-25.1.2.4 Polyphenylenes. A hydrocarbon parent component consisting of a monocyclic hydrocarbon with an even number of carbon atoms and benzene rings *ortho*-fused to alternate sides is named by citing a numerical prefix ('tri', 'tetra', etc.) denoting the number of benzene rings followed by the term 'phenylene'. The traditional name biphenylene is retained.

Examples:

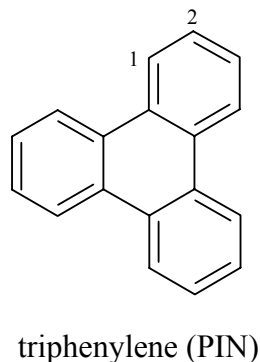
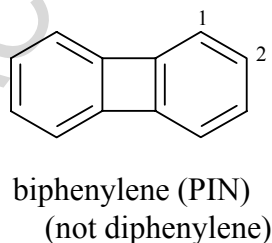

P-25.1.2.5 Polynaphthylenes. A hydrocarbon parent component that consists of a monocyclic hydrocarbon with an even number of carbon atoms *ortho*-fused on alternate sides to the 2,3-positions of naphthalene rings is named by citing a numerical prefix ('tri', 'tetra', etc.) denoting the number of naphthalene rings followed by the term 'naphthylene'. The series begins with three naphthalene rings, trinaphthylene. The first member of the series, which would be dinaphthylene, is named as a fused hydrocarbon, i.e., dibenzo[*b,h*]biphenylene, and thus is not considered as a parent component.

Examples:

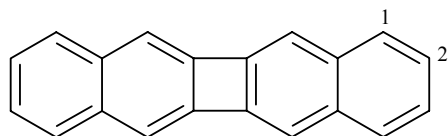

dibenzo[*b,h*]biphenylene (PIN)
(not dinaphthylene)

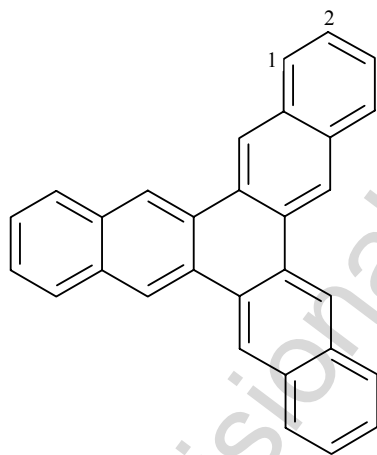

trinaphthylene (PIN)

P-25.1.2.6 Polyhelicenes. A hydrocarbon parent component of six or more rings that consists of a benzene ring *ortho*-fused to the 3,4-position of phenanthrene and further benzene rings fused in a similar way is named by citing a numerical prefix ('hexa', 'hepta', etc.) denoting the total number of benzene rings forming a helical arrangement followed by the term 'helicene'.

Note that the definition of polyhelicenes has been changed. The series begins with six rings and not five rings as indicated in the 1993 Guide (R-2.4.1.3.6 in ref. 2) and in the Glossary of Class Names (ref. 17). A further change related to the orientation and numbering has been recommended in the comprehensive fused ring nomenclature document 'Nomenclature of Fused and Bridged Fused Systems' (ref. 4). This new orientation and numbering are presented in Section P-25.3.3.

Example:

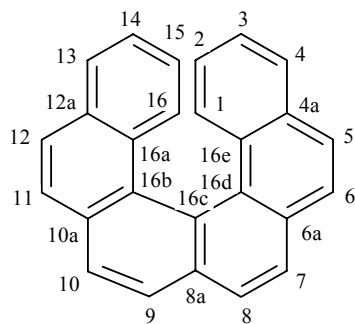

hexahelicene (PIN)
(new orientation
and numbering)

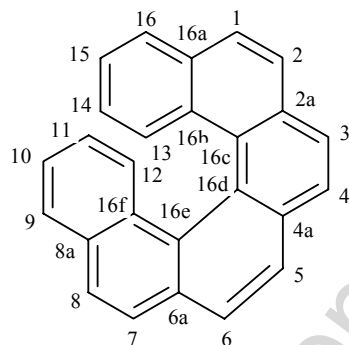

(orientation and numbering
no longer recommended; but
still in use by CAS, ref 16)

P-25.1.2.7 Ace...ylenes. A hydrocarbon parent component that consists of a five membered ring *ortho*- and *peri*-fused to naphthalene, anthracene, or phenanthrene is named by adding the prefix 'ace' to the retained name and changing the ending 'alene', 'acene', or 'ene', respectively, to 'ylene'.

Examples:

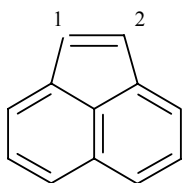

acenaphthylene (PIN)

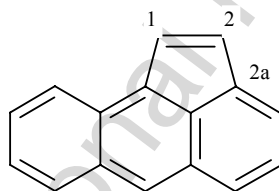

aceanthrylene (PIN)

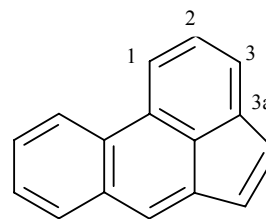

acephenanthrylene (PIN)

P-25.2 Names of heterocyclic parent components are divided into two categories.

P-25.2.1 Retained names used for parent components and as attached components

P-25.2.2 Names formed systematically using endings and prefixes used for parent components and attached components

P-25.2.1 Retained names for heterocycles (also called trivial names) with the maximum number of noncumulative double bonds (mancude systems) used for parent components and as attached components are given in Table 2.8.

Ring systems are arranged in decreasing order of seniority for parent compounds in accordance with the seniority order described in Section P-25.4.2.2 and exemplified in Section P-25.9.1.

Functional replacement, as described in Section P-35 is used to replace O by S, Se, and Te to generate names of chalcogen analogues of chromene, isochromene and xanthene (see Table

2.8). Some names listed in Table 2.8 can be modified by a system of replacement specific to some nitrogen-containing compounds, in which N is replaced by As or P. The modified names are listed in Table 2.9; the modifiable compounds are marked by the symbol \diamond in Table 2.8.

Rules for numbering are described in Section 25.3.3.

Table 2.8 Retained names of heterocyclic parent components in descending order of seniority (the seniority order is indicated by the number preceding the name; the lower the number, the higher the seniority; names denoted by the symbol \diamond are further modified as shown in Table 2.9)

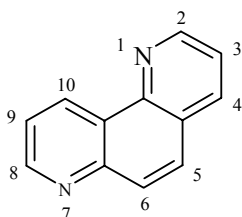

(1) phenanthroline (PIN)
(1,7-isomer shown; other isomers are: 1,8-; 1,9-; 1,10-; 2,7-; 2,8-; 2,9-; 3,7-; 3,8-; 4,7-)

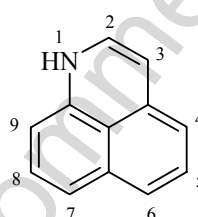

(2) perimidine (PIN)
(1H-isomer shown)

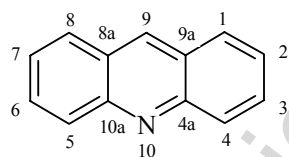

(3) acridine \diamond (PIN)
(special numbering)

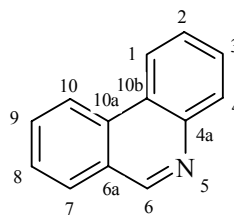

(4) phenanthridine \diamond (PIN)
(special numbering)

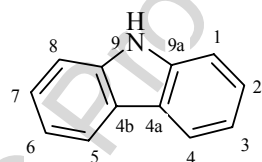

(5) carbazole (PIN)
(9H-isomer shown; special numbering)

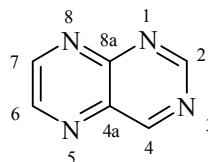

(6) pteridine (PIN)

Table 2.7 (cont'd.)

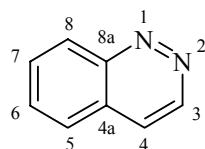

(7) cinnoline (PIN)

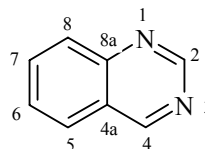

(8) quinazoline (PIN)

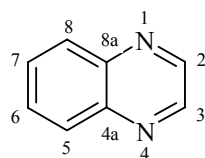

(9) quinoxaline (PIN)

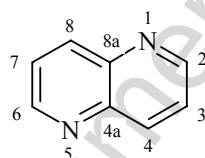

(10) naphthyridine (PIN)
(1,5-isomer; other isomers
are 1,6-; 1,7-; 1,8-; 2,6-; 2,7-)

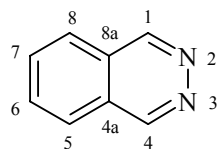

(11) phthalazine (PIN)

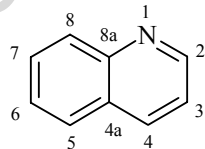

(12) quinoline \diamond (PIN)

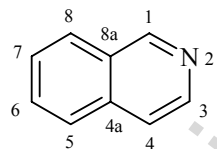

(13) isoquinoline \diamond (PIN)

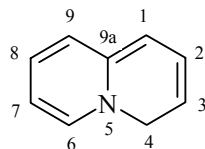

(14) quinolizine \diamond (PIN)
(4*H*-isomer shown)

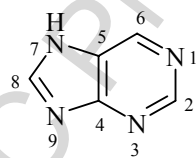

(15) purine (PIN)
(special numbering)

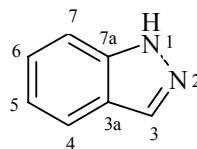

(16) indazole (PIN)
(1*H*-isomer shown)

Table 2.7 (cont'd)

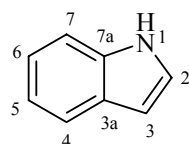

(17) indole \diamond (PIN)
(1*H*-isomer shown)

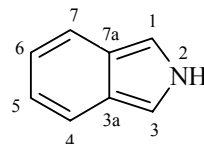

(18) isoindole \diamond (PIN)
(2*H*-isomer shown)

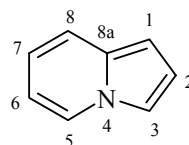

(19) indolizine \diamond (PIN)

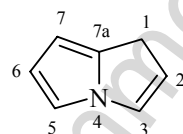

(20) pyrrolizine (PIN)
(1*H*-isomer shown)

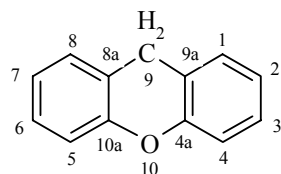

(21) xanthene (PIN)
(9*H*-isomer shown)
thioxanthene (S instead of O) (PIN)
selenoxanthene (Se instead of O) (PIN)
telluroxanthene (Te instead of O) (PIN)

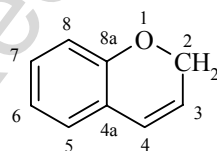

(22) chromene (PIN)
(2*H*-isomer shown)
thiochromene (S instead of O) (PIN)
selenochromene (Se instead of O) (PIN)
tellurochromene (Te instead of O) (PIN)

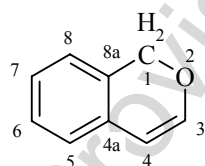

(23) isochromene (PIN)
(1*H*-isomer shown)
isothiochromene (S instead of O) (PIN)
isoselenochromene (Se instead of O) (PIN)
isotellurochromene (Te instead of O) (PIN)

Table 2.9 Names for nitrogenous parent components modified by P and As replacement
(For the seniority of P and As containing ring systems see P-25.3.2.4 and P-25.8.1)

In the following names, arsenic or phosphorus atoms replace nitrogen atoms

Nitrogen ring system	Arsenic ring system	Phosphorus ring system
acridine (PIN)	acridarsine (PIN)	acridophosphine (PIN)
indole (PIN)	arsindole (PIN)	phosphindole (PIN)
indolizine (PIN)	arsindolizine (PIN)	phosphindolizine (PIN)
isoindole (PIN)	isoarsindole (PIN)	isophosphindole (PIN)
isoquinoline (PIN)	isoarsinoline (PIN)	isophosphinoline (PIN)
phenanthridine (PIN)	arsanthridine (PIN)	phosphanthridine (PIN)
quinoline (PIN)	arsinoline (PIN)	phosphinoline (PIN)
quinolizine (PIN)	arsinolizine (PIN)	phosphinolizine (PIN)

P-25.2.2 Systematically named heterocyclic components

P-25.2.2.1 Heteromonocyclic parent components

P-25.2.2.2 Heteranthrene components

P-25.2.2.3 Pheno...ine components

P-25.2.2.4 Heteromonocyclic components fused to a benzene ring

P-25.2.2.1 Heteromonocyclic parent components

P-25.2.2.1.1 Heteromonocyclic rings with three through ten ring members having the maximum number of noncumulative double bonds are used as parent components as well as attached components. Retained names are given in Tables 2.2 and 2.3. Hantzsch-Widman names are discussed in P-22.2.2.

P-25.2.2.1.2 Names of heteromonocyclic parent components with more than ten ring members used in fusion nomenclature are discussed in this subsection; they are used only in fusion nomenclature.

A heteromonocyclic parent component having more than ten members and the maximum number of noncumulative double bonds (mancude) is named by changing the ending 'ane' of the corresponding saturated heteromonocycle (see P- 22.2.3) to 'ine'.

For examples of fusion compounds including this type of heteromonocyclic components, see P-25.2.2.4.

Examples:

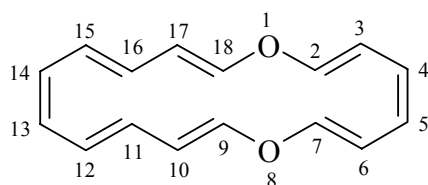

1,8-dioxacyclooctadecine
 1,8-dioxacyclooctadeca-2,4,6,9,11,13,15,17-octaene (PIN)

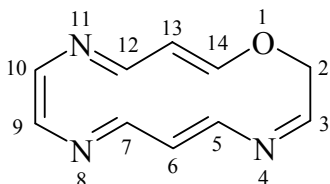

2*H*-1-oxa-4,8,11-triazacyclotetradecine
 1-oxa-4,8,11-triazacyclotetradeca-3,5,7,9,11,13-hexaene (PIN)

P-25.2.2.2 Heteranthrene components

A heterotricyclic parent component consisting of two benzene rings fused to a 1,4-dihetera-benzene in which the heteroatoms are the same is named by attaching the appropriate 'a' prefix to the ending 'anthrene' (from anthracene), with elision of a letter 'a'. The allowed heteroatoms are O, S, Se, Te, P, As, Si, and B. When the heteroatoms are nitrogen atoms, the component is named 'phenazine' (a retained name). The numbering is standard, as shown. Rules for numbering are described in Section P-25.3.3.

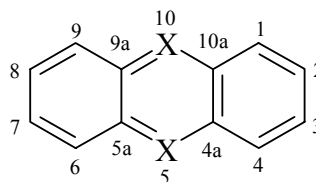
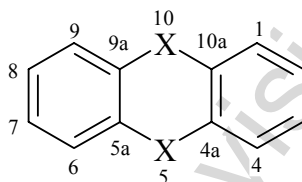

X = O oxanthrene (PIN)
 (formerly dibenzo[1,4]dioxine)

X = P phosphanthrene (PIN)

X = S thianthrene (PIN)

X = As arsanthrene (PIN)

X = Se selenanthrene (PIN)

X = SiH silanthrene (PIN)

X = Te telluranthrene (PIN)

X = B boranthrene (PIN)

P-25.2.2.3 Pheno...ine components

A heterotricyclic parent component consisting of two benzene rings fused to a 1,4-dihetera-benzene in which the heteroatoms are different is named by adding the prefix 'pheno' to the appropriate Hantzsch-Widman name (see P-22.2.2), eliding the 'o' before a following vowel.

Numbering is standard and depends on the nature of the heteroatoms. Rules for numbering are described in Section 25.3.3.

Examples:

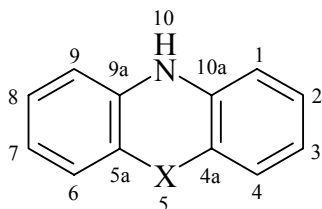

- X = O phenoxazine (PIN, 10*H*-isomer shown)
X = S phenothiazine (PIN, 10*H*-isomer shown)
X = Se phenoselenazine (PIN, 10*H*-isomer shown)
X = Te phenotellurazine (PIN, 10*H*-isomer shown)

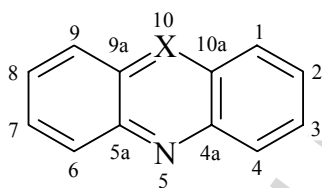

- X = P phenophosphazinine (PIN)
(formerly called phenophosphazine)
X = As phenarsazinine (PIN)
(formerly called phenoarsazine)

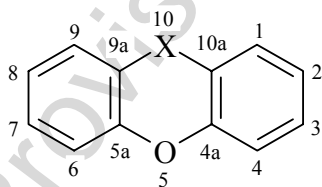

- X = S phenoxathiine (PIN)
X = Se phenoxaselenine (PIN)
X = Te phenoxatellurine (PIN)
X = PH phenoxaphosphinine (PIN, 10*H*-isomer shown)
(formerly called phenoxaphosphine)
X = AsH phenoxarsinine (PIN, 10*H*-isomer shown)
(formerly called phenoxarsine)

X = SbH phenoxastibinine (PIN, 10*H*-isomer shown)
(formerly called phenoxantimonine)

X = AsH₃ and S instead of O: phenothiarinine (PIN, 10*H*-isomer shown)
(formerly called phenothiarine)

P-25.2.2.4 Heteromonocyclic components fused to a benzene ring

Unless listed as a retained name in Table 2.7, such as quinoline and cinnoline, a benzene ring fused to a heteromonocycle of five or more members (a benzoheterocycle) is named by placing the locant(s) indicating the position(s) of the heteroatom(s) at the front of the name consisting of the fusion prefix 'benzo' followed by a retained name, a Hantzsch-Widman systematic name, or a name formed by skeletal replacement ('a') nomenclature as described in P-25.2.2.1.2. The locants cited correspond to the full bicyclic structure. As in Hantzsch-Widman names, locants are placed in the order corresponding to the order of citation of the heteroatoms in the heterocyclic component. The locant '1' is always assigned to the atom of the heterocyclic component next to a fusion atom. Heteroatoms are allocated lowest locants as a set, without regard to kind; if there is a choice, lowest locants are assigned in accordance with the seniority of the 'a' prefixes (see Table 2.3). Locants may be omitted when the name is unambiguous. The letter 'o' of the 'benzo' prefix is elided when followed by a vowel. Indicated hydrogen is placed at the front of the name, when required.

"Benzo names" offer several advantages. They are simpler in the sense that they do not require fusion descriptors. However, their primary advantage is in their use as components of fusion names; they provide a larger portion of structure and remove one full level in the construction of names for larger heterocyclic fused ring systems.

Examples:

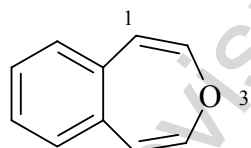

3-benzoxepine (PIN)
(not benzo[*d*]oxepine)
(not 3-benzooxepine)

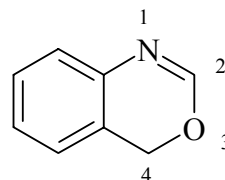

4*H*-3,1-benzoxazine (PIN)
(not 4*H*-benzo[*d*][1,3]oxazine)
(not 4*H*-3,1-benzooxazine)

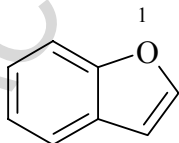

1-benzofuran (PIN)
(not benzofuran)
(not benzo[*b*]furan)

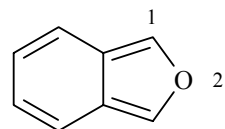

2-benzofuran (PIN)
(not isobenzofuran)
(not benzo[*c*]furan)

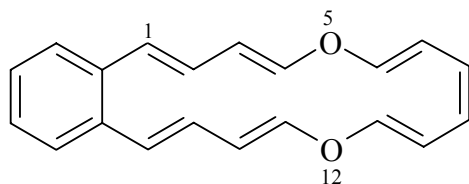

5,12-benzodioxacyclooctadecine (PIN)
(not benzo[*m*][1,8]dioxacyclooctadecine)

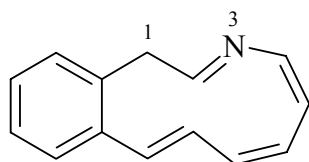

1*H*-3-benzazacycloundecine (PIN)
(not 1*H*-benzo[*h*][1]azacycloundecine)
(not 1*H*-3-benzoazacycloundecine)

P-25.3 Constructing fusion names

- P-25.3.1 Definitions, terminology and general principles
- P-25.3.2 Constructing two component fusion names
- P-25.3.3 Numbering fused systems
- P-25.3.4 Constructing polycomponent fusion names
- P-25.3.5 Heteromonocyclic ring fused to a benzene ring
- P-25.3.6 Treatment of identical attached components
- P-25.3.7 Multiparent systems
- P-25.3.8 Omission of locants

P-25.3.1 Definitions, terminology and general principles

P-25.3.1.1 Definitions

P-25.3.1.1.1 *ortho*-Fused. Two rings that have only two atoms and one bond in common are said to be *ortho*-fused.

Example:

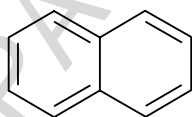

The two benzene rings of naphthalene are *ortho*-fused.

P-25.3.1.1.2 *ortho*- and *peri*-Fused. In a polycyclic compound a ring *ortho*-fused to different sides of two other rings that are themselves *ortho*-fused together (i.e. there are three

common atoms between the first ring and the other two) is said to be *ortho*- and *peri*-fused to the other two rings.

Example:

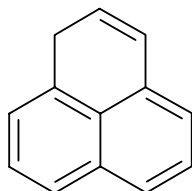

phenalene is considered as being composed of three benzene rings, each of which is *ortho*- and *peri*-fused to the other two.

P-25.3.1.1.3 Fusion atom. Any atom of a fused ring system that is common to two or more rings.

P-25.3.1.1.4 Peripheral atom. Any atom that forms part of the outer perimeter of a fused ring system

P-25.3.1.1.5 Interior atom. Any fusion atom that is not peripheral.

P-25.3.1.2 Terminology

P-25.3.1.2.1 Components of a fused ring system. Fusion components are mancade rings or ring systems that can be named without the application of any fusion nomenclature principles. Fused ring systems that do not have such a name are named by joining together the names of appropriately selected fusion components.

P-25.3.1.2.2 Parent component. The parent component according to the terminology of the 1998 recommendations (ref. 4) (referred to as base component in the 1979 publication, 1; and principal component in the 1993 Recommendations, ref. 2) is the one with highest seniority according to the criteria given in P-25.3.2.4. A parent component may be mono- or polycyclic, but it must be a mancade ring or ring system. Its name is never modified and is cited last in the name of the fused system.

P-25.3.1.2.3 Attached component. The components of a fused system not included in the parent component are called attached components. The attached components are called first-order, second-order, etc. attached components when they correspond to the first, second, etc. attached component reached when moving away from the parent component across fusion sites. An attached component may be mono- or polycyclic, but it must be a mancade ring or ring system. Fusion sites are bold lines in the following examples.

Example:

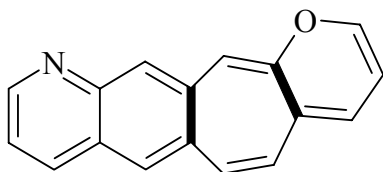

The bicyclic component at the left end of the above structure is the parent component, the seven-membered ring fused to the parent component is the first-order attached component; the six-membered ring fused to the first-order attached component is the second-order attached component. □

P-25.3.1.2.4 Interparent component. In a system that consists of two (or more) parent components *ortho*- or *ortho*- and *peri*-fused to the same attached component, the latter is called interparent component. Likewise, if two (or more) parent components are fused to three or more appropriately attached components, there will be two first-order interparent components and a second-order interparent component. Fourth-, fifth-, etc. order components may be present in more complex systems.

Example:

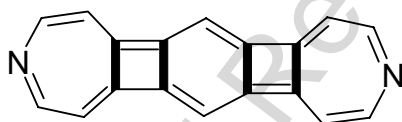

The two seven-membered rings are the parent components; the two four-membered rings are the first order interparent components; the six-membered ring is the second-order interparent component.

P-25.3.1.3 General principles

'*ortho*-Fused' or '*ortho*- and *peri*-fused' polycyclic systems with the maximum number of noncumulative double bonds (mancude) containing at least two rings of five or more members, and that have no accepted retained or systematic name described in sections P-25.1 and P-25.2 are named by prefixing to the name of a component ring or ring system (the parent component) designations of the other component(s) (attached components).

In the 1998 Recommendations (ref 4), the requirement that for application of fusion nomenclature at least two rings of five or members must be present, contained in the 1979 Recommendations (ref 1), was removed. For selection of Preferred IUPAC Names, this requirement is reinstated here. However, in general nomenclature, the fusion system can be applied equally to smaller rings, as in cyclobutabenzene.

The parent component is selected by applying criteria of seniority as described in P-25.3.2.4 below. In a fusion name, the name of the parent component is that of the component itself. The

names of attached components are formed by replacing the last letter 'e' by 'o' in the name of the component, i.e., indeno from indene (or by adding the letter 'o' when no final letter 'e' is present, i.e., pyrano from pyran) or by other means described in P-25.3.2.2 below. There is no elision of the final letter 'o' or 'a' before a vowel (see Rule FR-4.7, ref. 4).

Locants that describe structural features of components, such as positions of heteroatoms, are kept with the name of the component and are enclosed within square brackets.

In previous rules (Rule A-21.4, ref. 1), the elision of the final letter 'o' of acenaphtho, benzo, naphtho and perylo and the final letter 'a' of the monocyclic prefixes cyclopropa, cyclobuta, etc. was recommended. This practice is still used in Chemical Abstracts index nomenclature for acenaphtho, benzo, naphtho and the cycloalka prefixes. Names such as benzo[g]isoquinoline and cyclohepta[*cd*]-*s*-indacene are now recommended in place of benz[*g*]isoquinoline and cyclohept[*cd*]-*s*-indacene, respectively.

Isomers are distinguished by lettering, continuously, each peripheral side of the parent component (including sides whose locants are distinguished by letters, for example, 2a,3a) using the italic letters *a*, *b*, *c*, etc., beginning with *a* for the side numbered 1,2; *b* for 2,3; etc.. To the letter as early in the alphabet as possible that denotes the side where the fusion occurs are prefixed, if necessary, the numbers of the positions of attachment of the other component. These numbers are chosen to be as low as is consistent with the numbering of the compound and their order conforms to the direction of lettering of the parent component. In this document these letters and numbers are placed within the structure of the ring or ring system.

Examples:

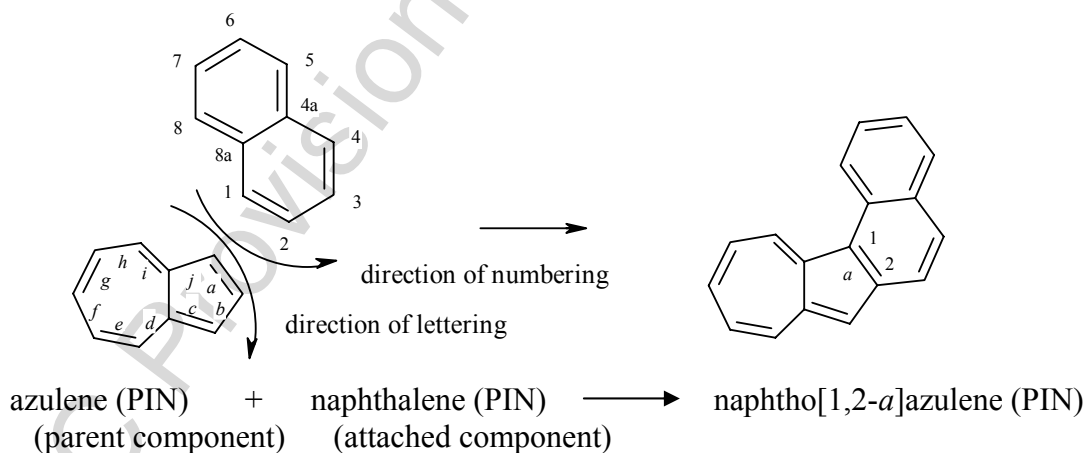

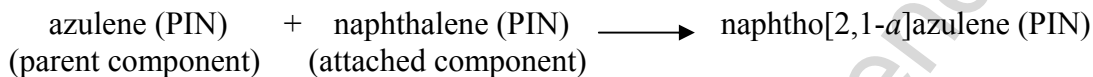
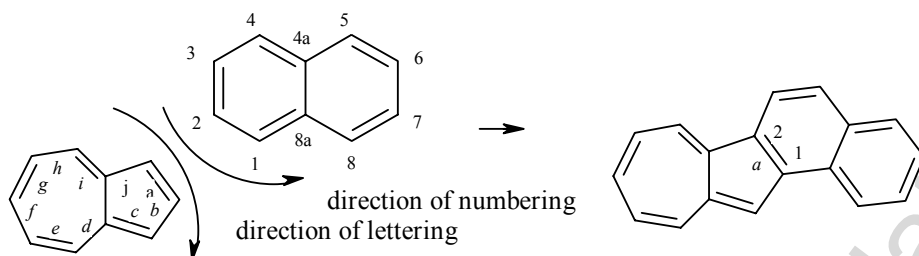

The numbers and letters, separated by commas when required, are enclosed in square brackets and placed immediately after the designation of the attached component; there is no space or hyphen either preceding or following the brackets. Hyphens separate the two parts of a fusion descriptor, i.e., numbers and italicized letters. This expression merely defines the manner of fusion of the components. Indicated hydrogen atoms are added to the names, as required, using locants characterizing the fused system.

Examples:

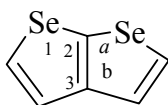

selenopheno[2,3-*b*]selenophene (PIN)

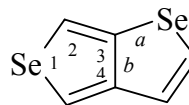

selenopheno[3,4-*b*]selenophene (PIN)

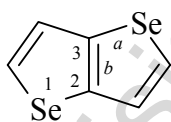

selenopheno[3,2-*b*]selenophene (PIN)

ortho- and *peri*-Fused systems require a fusion descriptor that indicates all fused bonds. All letters referring to the parent component are cited, but only locants of the nonfused atoms of the attached component are indicated. Letters are not separated by commas in the fusion descriptor.

Examples:

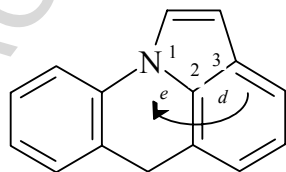

6*H*-pyrrolo[3,2,1-*de*]acridine

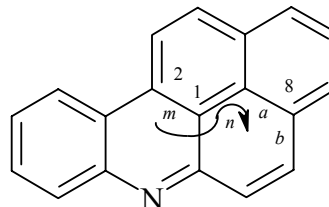

naphtho[2,1,8-*mna*]acridine

P-25.3.2 Constructing two component fusion names

A component may be monocyclic or polycyclic. Systematic construction proceeds stepwise, as follows.

- P-25.3.2.1 Selecting and naming parent components for fusion nomenclature
- P-25.3.2.2 Names of prefixes to denote attached components
- P-25.3.2.3 Orientation of fused ring systems
- P-25.3.2.4 Seniority criteria for selecting the parent components
- P-25.3.2.5 Assembling components and naming fused systems

P-25.3.2.1 Selecting and naming parent components for fusion nomenclature

P-25.3.2.1.1 Monocyclic hydrocarbons (Annulenes).

Monocyclic parent components are named as [*n*]annulenes where *n* represent the number of carbon atoms. The series starts at *n* = 7, because the retained name 'benzene' is preferred for *n* = 6. The use of the name 'annulene' in fusion nomenclature was recommended in 1993 (see R-2.4.1.1, ref. 2) to obviate the potential ambiguity of using contracted traditional names, such as cycloheptene to denote 1,3,5-cycloheptatriene.

Examples:

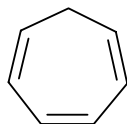

1*H*-[7]annulene
(no longer cycloheptene as
fusion component)
cyclohepta-1,3,5-triene (PIN)

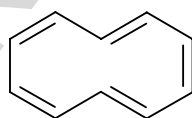

[10]annulene
(no longer cyclodecene as
fusion component)
cyclodeca-1,3,5,7,9-pentaene (PIN)

P-25.3.2.1.2 Heteromonocycles

The retained names given in Table 2.2, except for 'isothiazole', 'isoxazole', 'thiazole' and 'oxazole', and Hantzsch-Widman names for unsaturated heteromonocycles (see P-) are used as parent components in fusion nomenclature. The names 'isothiazole', 'isoxazole', 'thiazole' and 'oxazole', although permitted in general nomenclature, are not recommended for the names of components in preferred IUPAC fusion names. The Hantzsch-Widman names 1,2-thiazole, 1,2-oxazole, 1,3-thiazole and 1,3-oxazole, respectively, must be used; the locants are enclosed in square brackets in the completed fusion name.

Heteromonocycles having more than ten members and the maximum number of noncumulative double bonds whose names are denoted by the 'ine' ending described in P-22.2.4 are used as parent components in preferred IUPAC fusion names.

Examples:

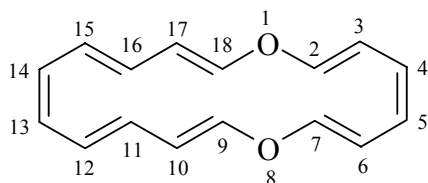

1,8-dioxacyclooctadecine
1,8-dioxacyclooctadeca-2,4,6,9,11,13,15,17-octaene (PIN)

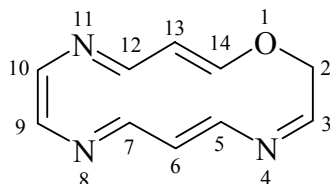

2*H*-1-oxa-4,8,11-triazacyclotetradecine
1-oxa-4,8,11-triazacyclotetradeca-3,5,7,9,11,13-hexaene (PIN)

P-25.3.2.1.3 Names of the hydrocarbons and heterocycles described in Sections P-25.1.2 and P-25.2.2 and retained names listed in Tables 2.2, 2.6 (see P-25.3.2.1.3 and P-25.3.2.1.4), 2.7, and 2.8 are used as parent components for preferred IUPAC fusion names.

P-25.3.2.2 Names of prefixes to denote attached components.

P-25.3.2.2.1 Monocyclic hydrocarbon prefixes for attached components other than 'benzo', are formed by dropping 'ne' from the name of the appropriate saturated monocyclic hydrocarbon. These names represent the form with the maximum number of noncumulative double bonds. There is no upper limit to this rule.

Examples:



cyclopropa (PIN)
(from cyclopropane, PIN)



cyclobuta (PIN)
(from cyclobutane, PIN)



cyclopenta (PIN)
(from cyclopentane, (PIN))

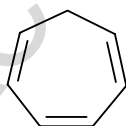

cyclohepta (PIN)
(from cycloheptane, (PIN))
(not [7]annuleno)

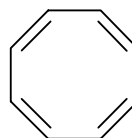

cycloocta (PIN)
(from cyclooctane, (PIN))
(not [8]annuleno)

P-25.3.2.2.2 Prefixes for attached components derived from the name of a parent component described in P-25.3.2.1.2 and P-25.3.2.1.2 are named by changing the final letter "e" in to the letter 'o' or by adding the letter 'o' when no final letter 'e' is present.

Examples:

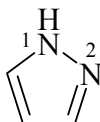

pyrazolo (PIN)
(derived from 1*H*-pyrazole, PIN)

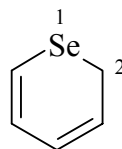

selenopyrano (PIN)
(derived from 2*H*-selenopyran, PIN)

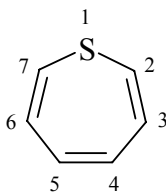

thiepino (PIN)
(derived from thiepine, (PIN))

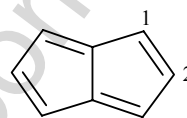

pentaleno (PIN)
(derived from pentalene, PIN)

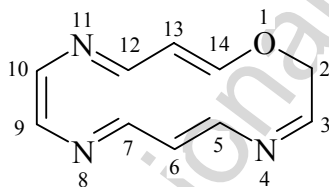

1-oxa-4,8,11-triazacyclotetradecino (PIN)
(derived from 2*H*-1-oxa-4,8,11-triazacyclotetradecine, PIN)

P-25.3.2.2.3 Retained names

Only the following contracted names are retained for preferred IUPAC fusion names:

anthra (PIN)	from anthracene (PIN)	naphtho (PIN)	from naphthalene (PIN)
benzo (PIN)	from benzene (PIN)	phenanthro (PIN)	from phenanthrene (PIN)
furo (PIN)	from furan (PIN)	imidazo (PIN)	from imidazole (PIN)
pyrido (PIN)	from pyridine (PIN)	pyrimido (PIN)	from pyrimidine (PIN)
thieno (PIN)	from thiophene (PIN)		

P-25.3.2.3 Orientation of fused ring systems

P-25.3.2.3.1 Drawing of ring structures

For the purpose of selecting parent components and for numbering of fused ring systems, the structures of fused ring compounds must be drawn in a specific manner according to a set of criteria that must be applied in order until a decision is reached.

Individual rings of a polycyclic 'ortho-fused' or 'ortho- and peri-fused' hydrocarbon ring system are drawn in such a way so that as many as possible of the various individual rings are arranged in horizontal rows. Such rows are characterized by a horizontal axis that divides each individual ring into two approximate halves. Permitted shapes for three to eight membered rings are as follows:

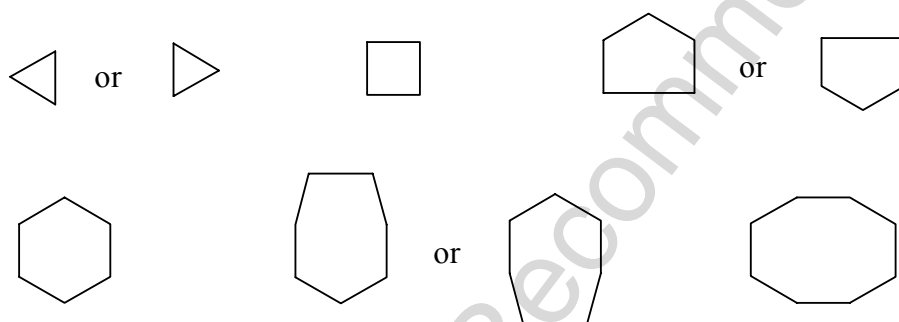

Example:

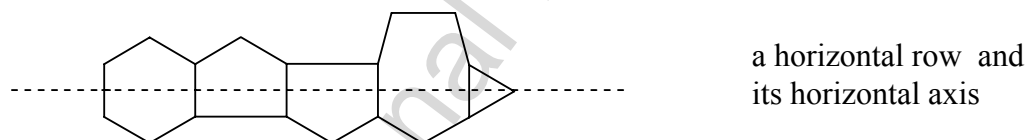

P-25.3.2.3.2 Criteria for the selection of the preferred orientation

Polycyclic fused ring systems are oriented in accordance with the following criteria, that are considered in order until a decision is reached.

(a) Maximum number of rings in a horizontal row.

Fused ring systems are drawn in order to achieve the maximum number of *ortho*-fused rings, with vertical common bonds, in a horizontal row. The relevant vertical bonds are always those furthest apart. If the correct orientation is not immediately apparent the horizontal row is bisected by a horizontal axis and a vertical axis to form four quadrants. Rings which are not bisected by the horizontal axis do not belong to the main row and are not considered in the counting of rings in the main row.

Example:

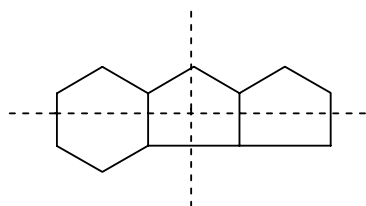

3 rings in horizontal row

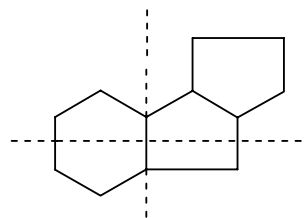

2 rings in horizontal row

Accordingly, polyacenes are senior to polyaphenes for an equal number of rings, and anthracene is senior to phenanthrene

(b) Maximum number of rings in upper right quadrant

In the preferred orientation, the maximum number of rings must appear above and to the right of the horizontal row (upper right quadrant). For this purpose, the center of the horizontal row is defined as the central common bond if there is an even number of rings in the row, and the center of the central ring if there is an odd number of rings. In counting rings in a quadrant those rings that are divided by an axis are considered as two halves, and a ring bisected by both axes, counts as four quarters (one in each quadrant). Rings that are bisected by the horizontal axis but are not directly *ortho*-fused to the main row are not considered when counting how many rings are in the horizontal row.

Examples:

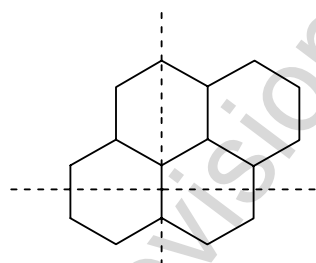

2 rings in horizontal row
2 rings in upper right quadrant
(correct orientation)

not

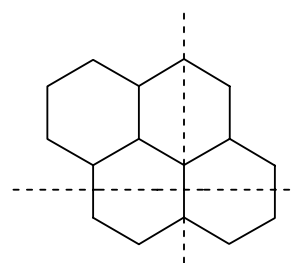

2 rings in horizontal row
1 ring in upper right quadrant
(incorrect orientation)

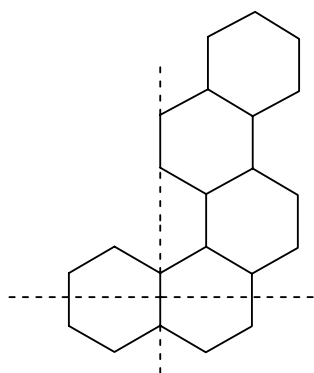

2 rings in the horizontal row
 $3\frac{1}{2}$ rings in upper right quadrant
(correct orientation)

not

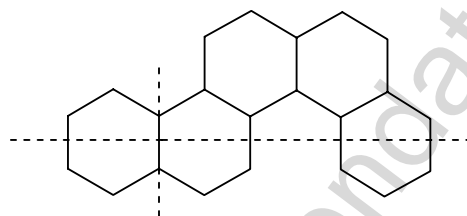

2 (not 3) rings in the horizontal row
3 rings in upper right quadrant
(incorrect orientation)

Accordingly, phenanthrene ($1\frac{1}{2}$ rings in the upper right quadrant) is senior to phenalene, [1 ring (two $\frac{1}{2}$ rings) in the upper right]quadrant.

(c) Minimum number of rings in the lower left quadrant.

Example:

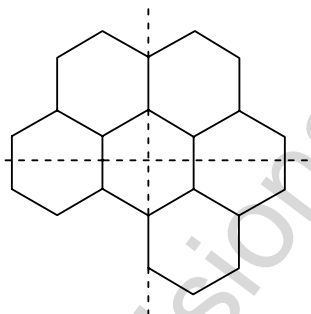

3 rings in horizontal row
 $1\frac{3}{4}$ rings in upper right quadrant
 $\frac{3}{4}$ ring in lower left quadrant

not

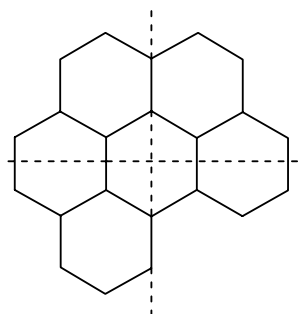

3 rings in horizontal row
 $1\frac{3}{4}$ rings in upper right quadrant
 $1\frac{3}{4}$ rings in lower left quadrant

(d) Maximum number of rings above the horizontal row

Example:

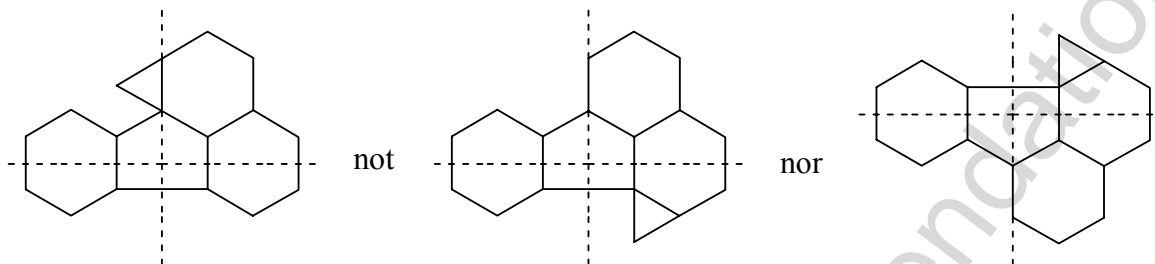

3 rings in horizontal row
 1 $\frac{3}{4}$ rings in upper right quadrant
 $\frac{3}{4}$ ring in lower left quadrant

3 $\frac{1}{2}$ rings above horizontal row
 row

not

3 rings in horizontal row
 1 $\frac{3}{4}$ rings in upper right quadrant
 $\frac{3}{4}$ ring in lower left quadrant

2 $\frac{1}{2}$ rings above horizontal row

nor

3 rings in horizontal row
 1 $\frac{3}{4}$ rings in upper right quadrant
 $\frac{3}{4}$ ring in lower left quadrant

2 $\frac{1}{2}$ rings above horizontal row

P-25.3.2.4 Seniority criteria for selecting the parent component

The components of the fused ring system are selected and named according to P-25.3.2.1 and P-25.3.2.2. When it is necessary to locate nomenclatural features, such as indicated hydrogen or atoms with nonstandard bonding numbers, another system of locants must be used, i.e., the locants that are used to number the completed fused ring system. In this document, these locants are placed outside the structure, as shown for retained names in Tables 2.2, 2.7, and 2.8. This system is fully explained and exemplified in P-25.3.3.

If there is a choice for selecting the parent component, the following criteria are considered, in order, until a decision can be made.

- (a) A component containing at least one of the heteroatoms occurring earlier in the following order: N > F > Cl > Br > I > O > S > Se > Te > P > As > Sb > Bi > Si > Ge > Sn > Pb > B > Al > Ga > In > Tl.

Examples:

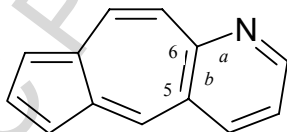

azuleno[6,5-*b*]pyridine (PIN)

[pyridine (heterocycle) is senior to azulene (carbocycle)]

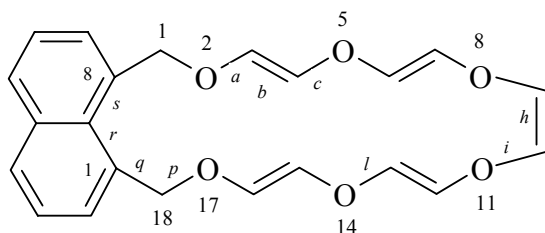

1*H*,18*H*-naphtho[1,8-*rs*][1,4,7,10,13,16]hexaoxacyclohenicosine (PIN)
 [1,4,7,10,13,16-hexaoxacyclohenicosine (heterocycle) is senior
 to naphthalene (carbocycle)]

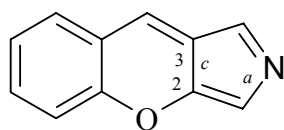

chromeno[2,3-*c*]pyrrole (PIN)
 (pyrrole is senior to chromene;
 N > O)

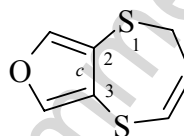

thiepino[2,3-*c*]furan (PIN)
 (furan is senior to thiepine;
 O > S)

(b) A component containing the greater number of rings.

Example:

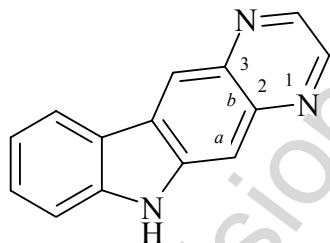

6*H*-pyrazino[2,3-*b*]carbazole (PIN)
 [carbazole (3 rings) is senior to quinoxaline (2 rings)]

(c) A component containing the larger ring at the first point of difference when comparing rings in order of decreasing size

Examples:

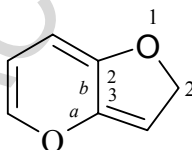

2*H*-furo[3,2-*b*]pyran (PIN)
 [pyran (6 ring) preferred
 to furan (5 ring)]

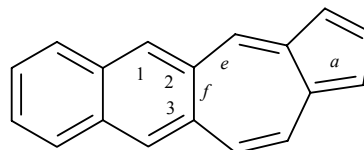

naphtho[2,3-*f*]azulene (PIN)
 [azulene (7,5 rings) preferred to
 to naphthalene (6,6 rings)]

(d) A component containing the greater number of heteroatoms of any kind.

Examples:

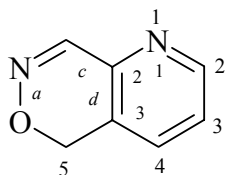

5H-pyrido[2,3-*d*][1,2]oxazine (PIN)
 [oxazine (2 heteroatoms) preferred
 to pyridine (1 heteroatom)]

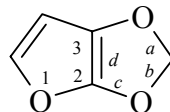

2H-furo[2,3-*d*][1,3]dioxole (PIN)
 [dioxole (2 heteroatoms) preferred
 to furan (1 heteroatom)]

(e) A component containing the greater variety of heteroatoms

Examples:

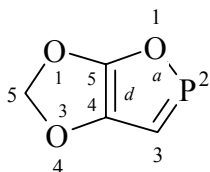

5H-[1,3]dioxolo[5,4-*d*][1,2]oxaphosphole (PIN)
 [1,3]dioxolo[*d*][1,2]oxaphosphole
 (an O and a P atom preferred to two O atoms)

(f) A component containing the greater number of heteroatoms most senior when considered in the order: F > Cl > Br > I > O > S > Se > Te > N > P > As > Sb > Bi > Si > Ge > Sn > Pb > B > Al > Ga > In > Tl.

Examples:

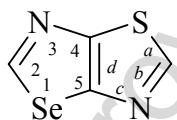

[1,3]selenazolo[5,4-*d*][1,3]thiazole (PIN)
 (S,N senior to Se,N)

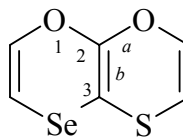

[1,4]oxaselenino[2,3-*b*]oxathiine (PIN)
 (O,S senior to O,Se)

(g) A component containing the greatest number of rings in a horizontal row when it is drawn in the preferred orientation according to P-25.3.2.3.

Examples:

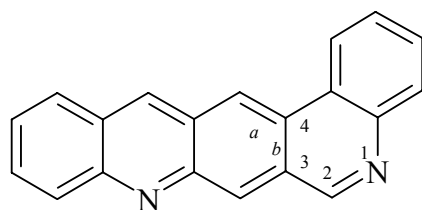

quinolino[4,3-*b*]acridine (PIN)
 [acridine (3 rings in horizontal row) preferred to phenanthridine (2 rings in horizontal row)]

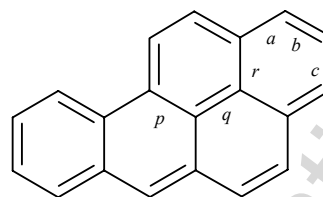

benzo[*pqr*]tetraphene (PIN)
 [tetraphene (3 rings in horizontal row) preferred to chrysene or pyrene (2 rings in horizontal row)]

(h) A component with the lower locants for heteroatoms

Example:

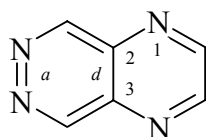

pyrazino[2,3-*d*]pyridazine (PIN)
 (locants '1,2' of pyridazine preferred to locants '1,4' of pyrazine)

(i) A component with the lower locants for the heteroatoms when considered in the order:
 F > Cl > Br > I > O > S > Se > Te > N > P > As > Sb > Bi > Si > Ge >
 Sn > Pb > B > Al > Ga > In > Tl.

Example:

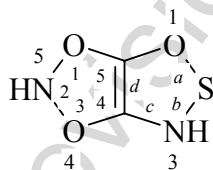

3*H*,5*H*-[1,3,2]oxathiazolo[4,5-*d*][1,2,3]oxathiazole (PIN)
 (locants '1,2,3' are senior to '1,3,2')

(j) A component with the lower locants for the peripheral fusion carbon atoms (see P-25.3.3.1 for numbering of fusion carbon atoms).

Example:

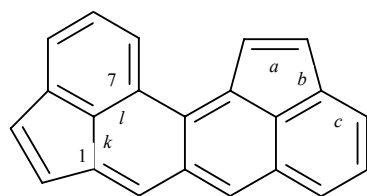

indeno[1,7-*k*l]aceanthrylene (PIN)
(the locant 2a in aceanthrylene is lower than 3a in acephenanthrylene; see below)

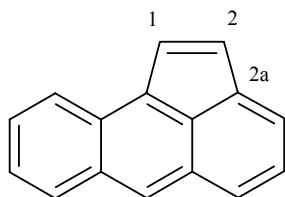

aceanthrylene (PIN)

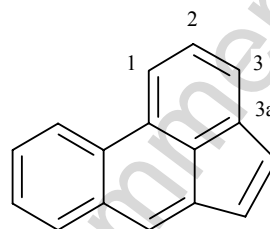

acephenanthrylene (PIN)

P-25.3.2.5 Assembling components and naming fused systems. The following are considered when assembling components and naming fused systems.

P-25.3.2.5.1 A heteroatom common to two components must be indicated in the name of each component.

Example:

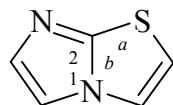

imidazo[2,1-*b*][1,3]thiazole (PIN)

P-25.3.2.5.2 An atom with a nonstandard bonding number is indicated by the lambda convention (see P-14.1) The nonstandard bonding number n is indicated as a superscript to the symbol λ , for example λ^5 ; this symbol follows the locant of the atom with the nonstandard bonding number in accordance with the numbering of the fused system and is cited at the beginning of the name of the fused ring system.

Example:

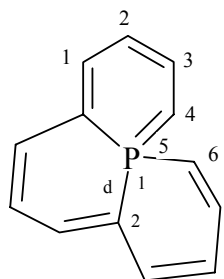

5λ⁵-phosphinino[2,1-*d*]phosphinolizine (PIN)

P-25.3.2.5.3 Indicated hydrogen is cited at the beginning of the name preceded by an appropriate locant of the fused ring system.

Example:

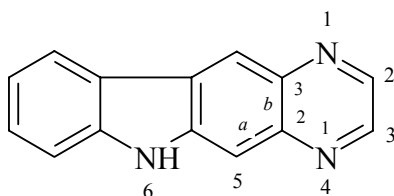

6*H*-pyrazino[2,3-*b*]carbazole (PIN)

P-25.3.3 Numbering fused ring systems

Fused systems with retained names, systematic names, or fused names are systematically numbered in the same manner. Anthracene, phenanthrene, acridine and carbazole are exceptions; their traditional numberings are retained. Two types of numbering are to be considered.

P-25.3.3.1 Peripheral numbering

P-25.3.3.2 Interior numbering

P-25.3.3.1 Peripheral numbering

P-25.3.3.1.1 The numbering of peripheral atoms in the preferred orientation starts from the uppermost ring in the upper right quadrant. If there is more than one uppermost ring the ring furthest to the right is chosen. Numbering starts from the nonfused atom most counterclockwise in the ring selected and proceeds in a clockwise direction around the system, including fusion heteroatoms but not fusion carbon atoms. Each fusion carbon atom is given the same number as the immediately preceding nonfusion skeletal atom, modified by a Roman letter 'a', 'b', 'c', 'd', etc.

Examples:

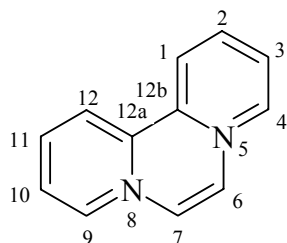

dipyrido[1,2-*a*:2',1'-*c*]pyrazine (PIN)

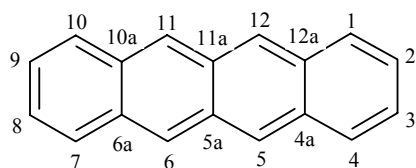

tetracene (PIN)

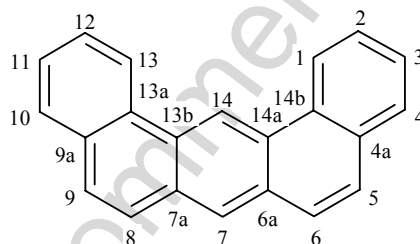

dibenzo[*a,j*]anthracene (PIN)

If a ring system does not have a nonfusion atom, then numbering starts in the next ring encountered when proceeding round the system in a clockwise direction.

Example:

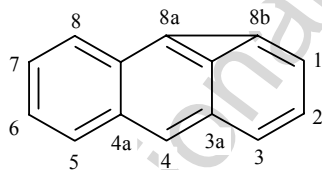

cyclopropa[*de*]anthracene (PIN)

Sections FR-5.3, FR-5.4 and FR-5.4 in ref. 4 describe numbering for more complex structures. In particular, the orientation and numbering of helicenes has been changed. The recommended numbering and former numbering for hexahelicene are shown below. Higher helicenes follow the same pattern. A helicene is oriented so that a terminal ring is located in the upper right quadrant; numbering always begins in this terminal ring.

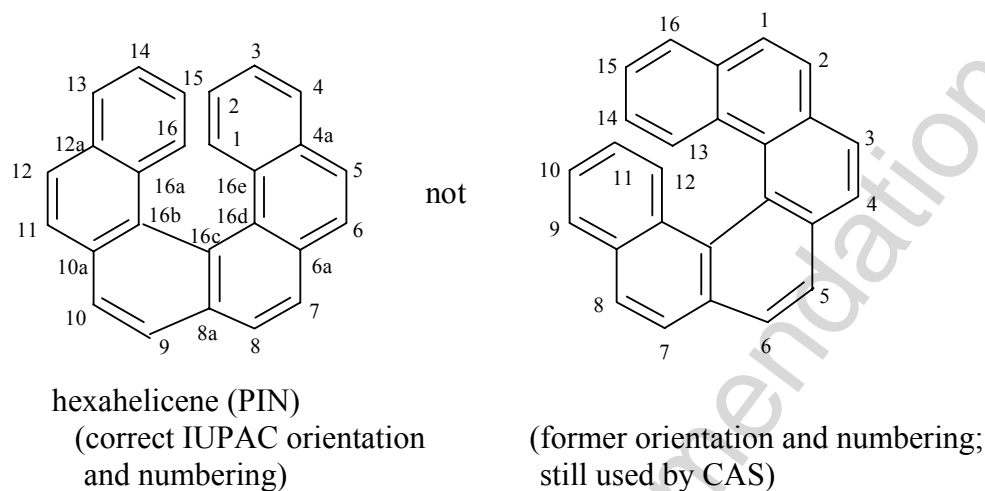

P-25.3.3.1.2 If alternative numbering for a ring system remains after the application of P-25.3.3.1.1 (including alternative locations for heteroatoms), the following criteria are applied in order until a decision is reached.

- (a) Low locants are assigned to heteroatoms, considered as a set without regard to kind

Examples:

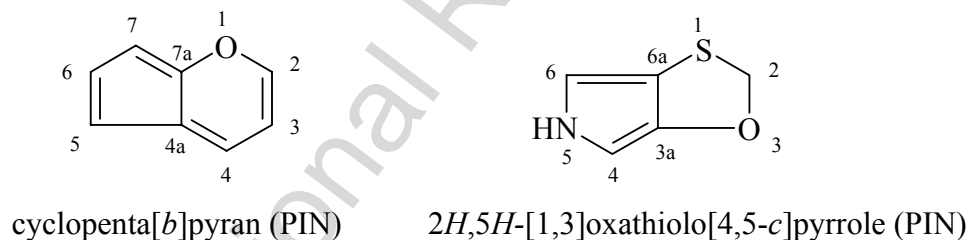

- (b) Low locants are assigned to heteroatoms in the order: F > Cl > Br > I > O > S > Se > Te > N > P > As > Sb > Bi > Si > Ge > Sn > Pb > B > Al > Ga > In > Tl.

Example:

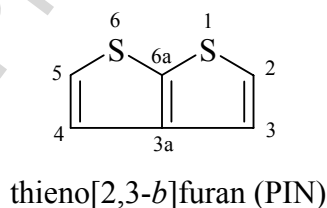

- (c) Low locants are assigned to fusion carbon atoms

Examples:

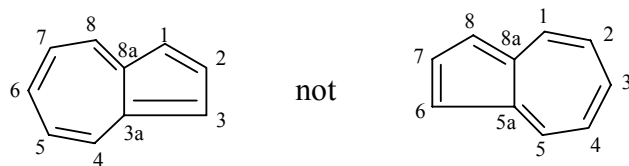

azulene (PIN)
 (locants 3a,8a are lower than 5a,8a)

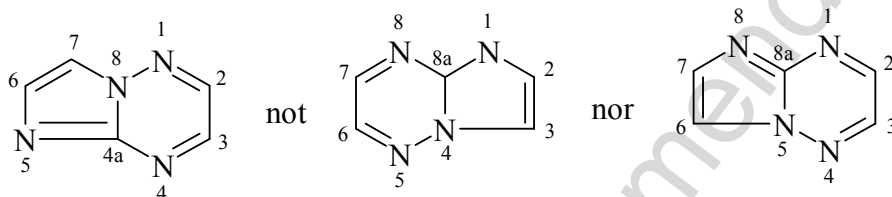

imidazo[1,2-*b*][1,2,4]triazine (PIN)
 (locant 4a is lower than 8a)

(d) Low locants are assigned to fusion rather than nonfusion heteroatoms of the same element.

Example:

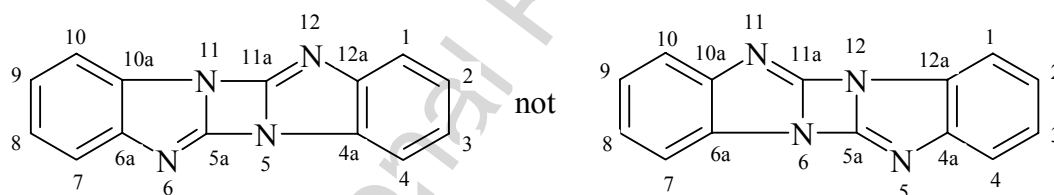

[1,3]diazeto[1,2-*a*:3,4-*a'*]dibenzimidazole (PIN)
 (5 is lower than 6)

(e) Low locants are assigned so that an interior heteroatom is nearer (i.e., fewer bonds in the pathway) to the lowest numbered fusion peripheral atom (see P-25.3.3.2 for interior numbering).

Example:

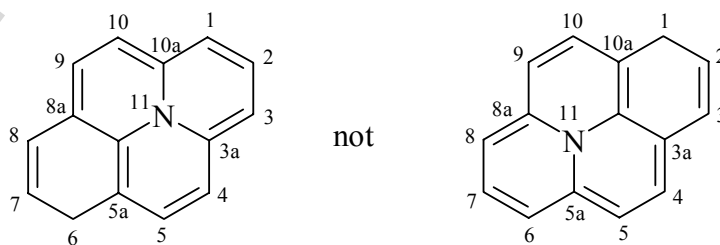

6*H*-quinolizino[3,4,5,6-*ija*]quinoline (PIN)

(3a is lower than 5a for the lowest locant next to the nitrogen atom)

(f) Low locants are assigned to indicated hydrogen atoms (expressed or implied)

Examples:

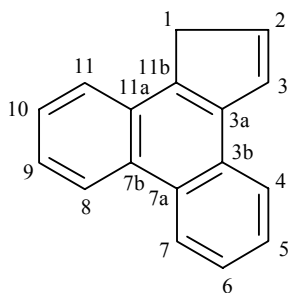

1*H*-cyclopenta[1]phenanthrene (PIN)

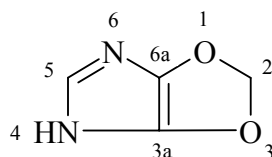

2*H*,4*H*-[1,3]dioxolo[4,5-*d*]imidazole (PIN)

correct

not

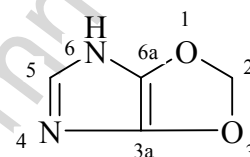

2*H*,6*H*-[1,3]dioxolo[4,5-*d*]imidazole

incorrect

(The locant set 2,4 for indicated hydrogen atoms is lower than 2,6)

P-25.3.3.2 Interior numbering of heteroatoms

P-25.3.3.2.1 Interior heteroatoms that are not identified by skeletal replacement (“a”) nomenclature are numbered after the peripheral atoms continuing the established number sequence [see also P-25.3.3.1.2(e)]. Compare the numbering of interior carbon atoms (see P-25.3.3.3).

Example:

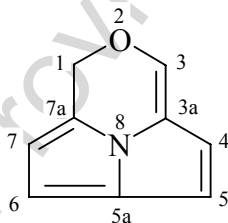

1*H*-[1,4]oxazino[3,4,5-*cd*]pyrrolizine (PIN)

P-25.3.3.2.2 If there is a choice, the shortest pathway in terms of the number of bonds from each heteroatom to the periphery is determined. The lower number is given to the heteroatom whose shortest pathway connects to the lowest numbered peripheral atom.

Example:

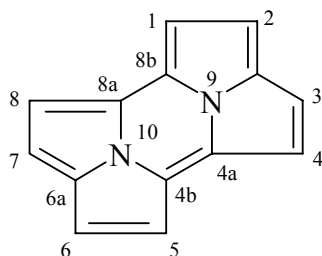

pyrazino[2,1,6-*cd*:3,4,5-*c'*,*d'*]dipyrrolizine (PIN)
(the heteroatom numbered 9 is one bond
away from 2a, which is lower than 4b)

P-25.3.3.2.3 If there is a choice between heteroatoms of different elements, the lower locant is assigned in accordance with the order F > Cl > Br > I > O > S > Se > Te > N > P > As > Sb > Bi > Si > Ge > Sn > Pb > B > Al > Ga > In > Tl.

Example:

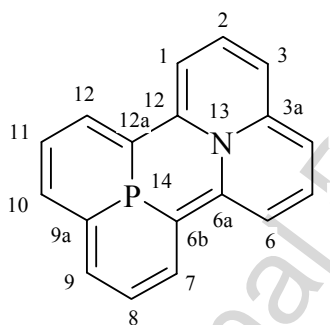

phosphinolizino[4',5',6':3,4,5][1,4]azaphosphinino[2,1,6-*de*]quinolizine (PIN)
(the nitrogen atom has a lower locant than the phosphorus atom)

P-25.3.3.3 Numbering of interior carbon atoms

A major change to the rule for interior numbering of carbon atoms is now recommended (see FR-5.5.2 in ref. 4). Interior atoms are numbered by identifying the minimum number of bonds linking them to a peripheral atom. The locant for the interior atom is that of the peripheral atom with a superscript number corresponding to the number of bonds between the two atoms. The previous rule (Rule A-22.2 in ref. 1) recommended that interior atoms follow the highest numbered peripheral atom adding Roman letters in sequence to the appropriate peripheral number.

Examples:

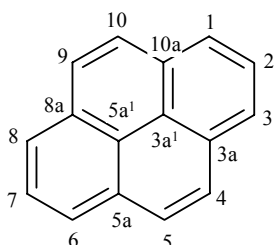

pyrene (PIN)
(recommended numbering)

not

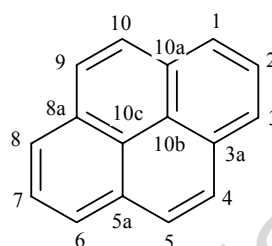

(former numbering, no longer recommended
but still used by CAS)

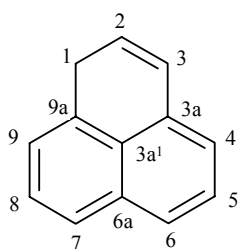

1*H*-phenalene (PIN)
(recommended numbering)

not

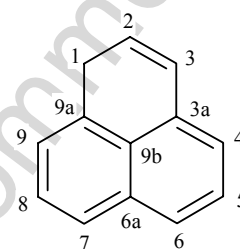

(former numbering, no longer recommended
but still used by CAS)

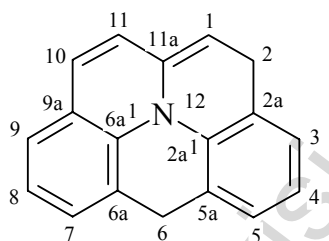

2*H*,6*H*-quinolizino[3,4,5,6,7-*defg*]acridine (PIN)
(recommended numbering)

not

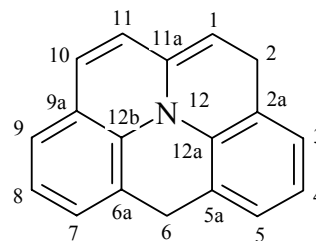

(former numbering, not recommended
but still used by CAS)

If there is a choice of interior atom locants lower locants are selected.

Example:

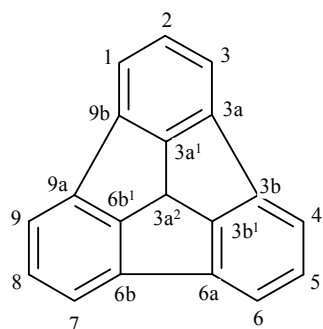

$3a^2H$ -benzo[3,4]pentaleno[2,1,6,5-*ijklm*]fluorine (PIN)
 (recommended numbering)

not

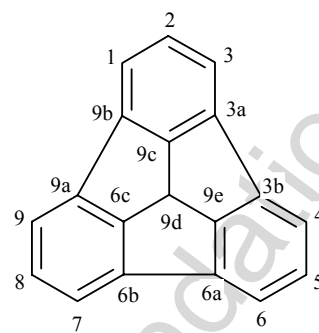

(former numbering, no longer recommended but still used by CAS)

P-25.3.4 Constructing polycyclic fused systems

When several components must be considered, one, and only one, can be the parent component. All other components are attached components. A component attached directly to the parent component is called a 'first-order component'. A component attached to a first-order component is called a 'second-order' component, and so on. The parent and the attached first order components are named as indicated for two component systems (see P-25.3.2).

P-25.3.4.1 Three types of fusion names are considered in these recommendations.

P-25.3.4.1.1 Fusion names composed of first- and higher attached components

P-25.3.4.1.2 Identical attached components

P-25.3.4.1.3 Multiparent names

P-25.3.4.1.1 Fusion names composed of attached first- and higher-order components

The procedure for indicating common bond(s) between an attached first order component and a higher order attached component follows that for the attachment of the parent compound to the first order attached component except that numerical locants are used instead of letters and the two sets of locants are separated by a colon. The locants of second order attached component are primed to contrast with those of first-order attached components. The locants of third order attached components are doubly primed, and so on.

Example:

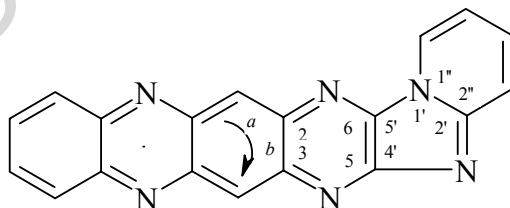

pyrido[1'',2'':1',2']imidazo[4',5':5,6]pyrazino[2,3-*b*]phenazine (PIN)

P-25.3.4.1.2 Identical attached components

Multiplicity of components that are identical and are all fused to a parent component or an attached component is indicated by the use of the prefix 'di-', 'tri-', etc. (or 'bis-', 'tris-', etc.). The multiplying prefix is not considered in deciding alphabetical order. A colon separates the sets of locants, and a comma is used when letters only are present.

Example:

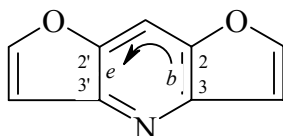

difuro[3,2-*b*:2',3'-*e*]pyridine (PIN)

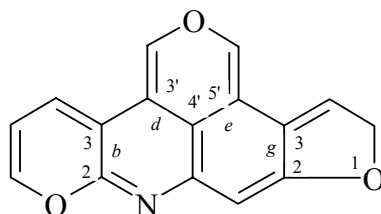

5H-furo[2,3-*g*]dipyrano[2,3-*b*:3',4',5'-*b*]quinoline (PIN)
(furo before dipyrano)

P-25.3.4.1.3 Multiparent names

Multiple occurrences of the parent component in a multiparent system is indicated by the use of multiplying prefixes, 'di', 'tri', etc. or 'bis', 'tris', etc. To distinguish between the parent components, the second has primed locants, the third double primed, etc.

Example:

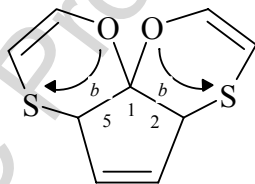

cyclopenta[1,2-*b*:5,1-*b*]bis[1,4]oxathiazine (PIN)

P-25.3.4.2 Constructing polycomponent fusion names

Polycomponent fusion names are constructed by using specific orders of seniority and rules. They are elaborated as follows.

- P-25.3.4.2.1 Order of seniority for selecting parent components
- P-25.3.4.2.2 Order of seniority for selecting attached components
- P-25.3.4.2.3 Order of citation of fusion prefixes
- P-25.3.4.2.4 Order of seniority of locants (letters and numbers)

P-25.3.4.2.1 Order of seniority for selecting parent components

When there are two or more locations for a parent component in a fused ring structure, the following criteria are applied sequentially until a complete distinction is obtained. In the examples below, the senior location is identified by a solid box and other locations with a dashed box. Second order components in names are in bold, for didactic purposes only.

The senior location is:

- (a) The location that enables the whole ring system to be named by fusion nomenclature, thus excluding names of bridge fused systems.

Example:

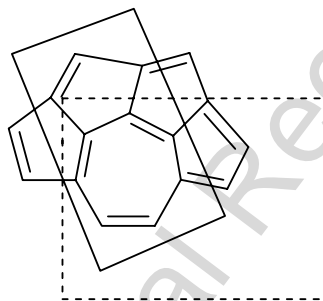

cyclopenta[*ij*]pentaleno[2,1,6-*cde*]azulene (PIN)
(not 1,9-methenopentaleno[1,6-*ef*]azulene)
(not 1,9-methenodicyclopenta[*cd,f*]azulene)
(names including the prefix 'metheno' are bridged fused names)

- (b) The location that results in a name that does not require attached components higher than first-order. For didactic purposes only, names of attached components of higher order than first-order are written in bold type.

Example:

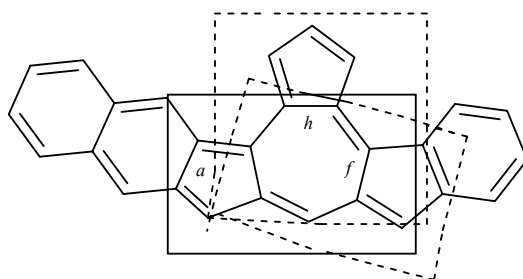

cyclopenta[*h*]indeno[2,1-*f*]naphtho[2,3-*a*]azulene (PIN)
(not benzo[*a*]benzo[5,6]indeno[2,1-*f*]cyclopenta[*h*]azulene
nor **benzo**[5,6]indeno[1,2-*e*]indeno[2,1-*h*]azulene; there is
no second-order component in the recommended name)

- (c) The location that results in the maximum number of first-order attached components, second-order components, etc. This criterion results in the minimum number of higher-order attached components, hence, fewer primed fusion descriptors.

Examples:

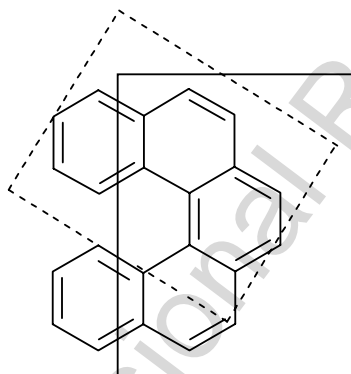

dibenzo[*c,g*]phenanthrene (PIN)
(not naphtho[2,1-*c*]phenanthrene; two
attached components preferred to one)

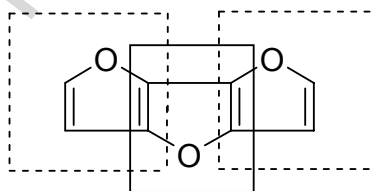

difuro[3,2-*b*:2',3'-*d*]furan (PIN, a multiplicative prefix name)
(not furo[3,2-*b*:4',5,-*b'*]difuran (a multiparent name)
(two attached components preferred to one)

- (d) A location that permits the expression of the maximum number of identical attached components with multiplicative prefixes.

Example:

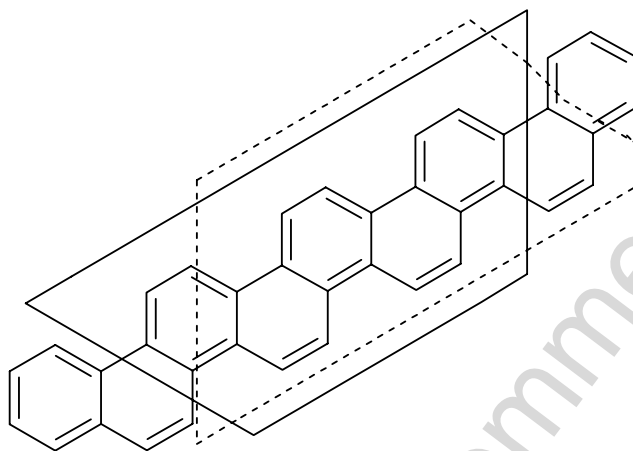

dinaphtho[1,2-*c*:2,1-*m*]picene (PIN)
(not benzo[*c*]phenanthreno[2,1-*m*]picene)

- (e) A location that uses a senior interparent component.

Example:

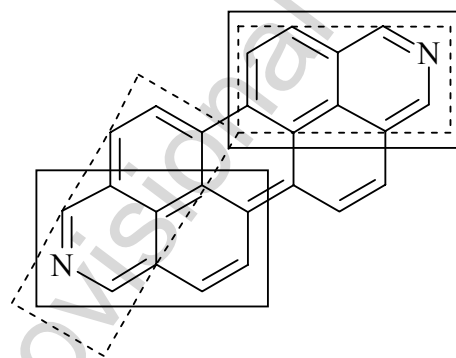

anthra[2,1,9-*def*:6,5,10-*d'e'f'*]diisoquinoline (PIN)
(not phenanthro[2,1,10-*def*:7,8,9-*d'e'f'*]diisoquinoline;
anthracene is senior to phenanthrene)

- (f) A location that results in preferred attached components, first-order, then second-order, etc. This criterion is embellished and illustrated in the original publication (see FR-3.1.1 in ref. 4).

P-25.3.4.2.2 Selection of attached components

After selection of the parent component (see P-25.3.2.4) [or parent components and interparent component(s) if a multiparent name is chosen], other rings are identified as far as

possible as attached components. If there is a choice, first-order attached components are considered first, then second-order components, etc. The following criteria are applied in order only until a complete decision is made.

In the examples below, the preferred attached component is marked with a solid box and the alternatives with dashed boxes.

- (a) If there are alternative first order attached components, the senior ring or ring system is selected. The same procedure is applied to second-order attached components, and so on.

Example:

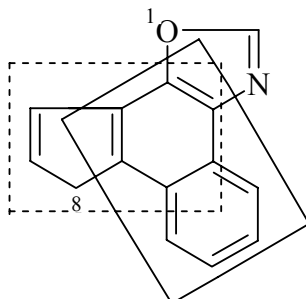

8H-cyclopenta[3,4]naphtho[1,2-*d*][1,3]oxazole (PIN)
(not *8H*-benzo[6,7]indeno[5,4-*d*][1,3]oxazole;
naphthalene is senior to indene)

- (b) The location that has lowest locants as a set for fusion to the parent component

Example:

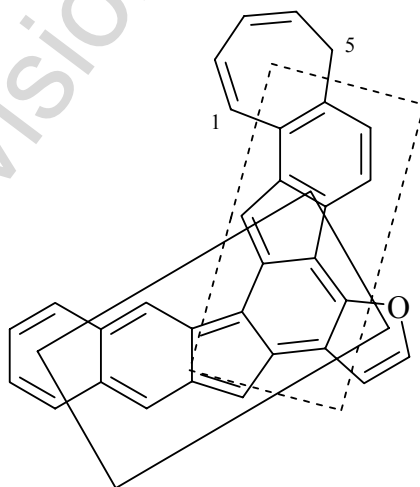

5H-benzo[6,7]cyclohepta[4',5']indeno[1',2':3,4]fluoreno[2,1-*b*]furan (PIN)
(not *5H*-benzo[5',6']indeno[1',2':1,2]cyclohepta[7,8]fluoreno[4,3-*b*]furan;
locants 1,2 are lower than 3,4 for the 'fluoreno' attached component)

- (c) The location that has lowest locants for fusion to the parent component in order of citation.

Example:

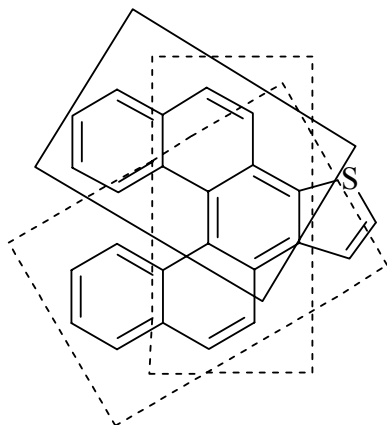

naphtho[2',1':3,4]phenanthro[1,2-*b*]thiophene (PIN)
(not naphtho[2',1':3,4]phenanthro[2,1-*b*]thiophene,
nor dibenzo[3,4:5,6]phenanthro[9,10-*b*]thiophene;
the locants '1,2' for the 'phenanthro' attached component,
in order of citation, are lower than '2,1' or '9,10')

This procedure is continued exploring outwards to the senior second-order attached components.

Example:

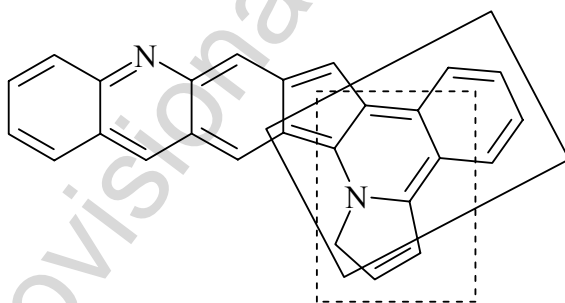

7*H*-pyrrolo[2'',1'':1',2']isoquinolino[4',3':4,5]cyclopenta[1,2-*b*]acridine (PIN)
(not 7*H*-benzo[7',8']indolizino[6',5':4,5]cyclopenta[1,2-*b*]acridine;
isoquinoline is senior to indolizine)

P-25.3.4.2.3 Order of citation of fusion prefixes

- (a) Fusion between two components is indicated by the method described in P-25.3.1. All attached components are cited in front of the parent component. Each second order attached component is cited at the front of the first order attached component to which it is fused, and so on to higher order attached components. If there are two or more different components, or sets of components, attached to a lower order component, they are cited in alphabetical order.

Examples:

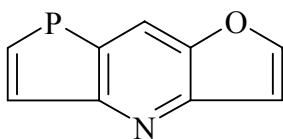

furo[3,2-*b*]thieno[2,3-*a*]pyridine (PIN)
(furo is cited before thieno)

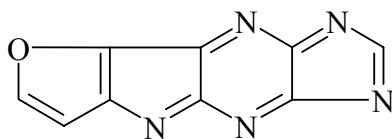

furo[2',3':4,5]pyrrolo[2,3-*b*]imidazo[4,5-*e*]pyrazine (PIN)
(furo...pyrrolo is cited before imidazo)

In the case of indacene, if the only distinction is between *as*-indacene and *s*-indacene, then the italic characters are considered. Otherwise, they are treated as indacene for consideration of alphabetical order. It should be noted that *s*-indacene is senior to *as*-indacene in the order of seniority of components.

Example:

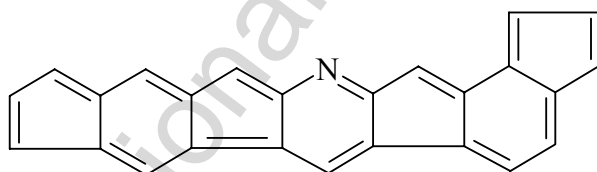

as-indaceno[2,3-*b*]-*s*-indaceno[1,2-*e*]pyridine (PIN)

- (b) If two or more identical components are fused to a third component, they are cited together using multiplying prefixes ('di', 'tri', etc.; or 'bis', 'tris', etc.). The citation of different components is in alphabetical order of the names of the components, just as for simple multiplicative prefixes in substitutive nomenclature. The multiplicative prefix is considered only when it is an integral part of a multipart fusion prefix.

Examples:

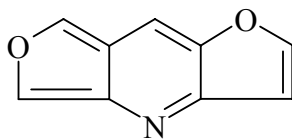

difuro[3,2-*b*:3',4'-*e*]pyridine (PIN)

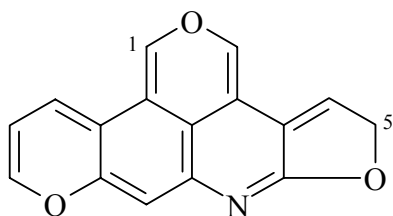

5H-furo[3,2-*g*]dipyrano[2,3-*b*;3',4',5'-*de*]quinoline (PIN)
(furo is cited before pyrano)

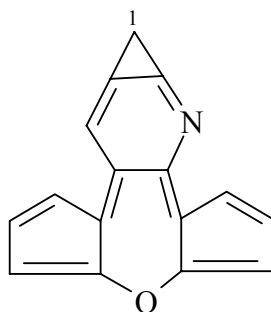

1H-cyclopropa[*b*]dicyclopenta[2,3:6,7]oxepino[4,5-*e*]pyridine (PIN)
(not *1H*-dicyclopenta[2,3:6,7]oxepino[4,5-*b*]cyclopropa[*e*]pyridine;
cyclopropa is cited before dicyclopentaoxepino, which is treated as
one component)

- (c) If two or more groups of components differ only by virtue of the fusion locants within the group, these locants are used to determine the order of citation of prefixes; lower locant sets are cited earlier.

Example:

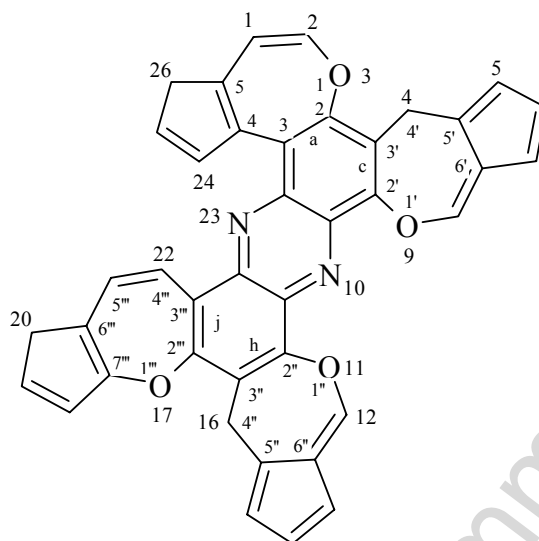

4H,16H,20H,26H-cyclopenta[4,5]oxepino[3,2-*a*]bis(cyclopenta[5,6]oxepino)[3',2'-*c*:2'',3''-*h*]cyclopenta[6''',7''']oxepino[2''',3'''-*j*]phenazine (PIN)

- (d) If two or more groups of components only differ by virtue of heteroatom locants, these locants are used to determine the order; lower locant sets are cited earlier.

Example:

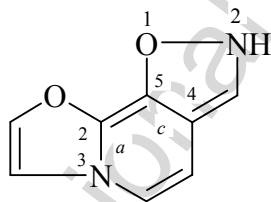

2H-[1,2]oxazolo[5,4-*c*][1,3]oxazolo[3,2-*a*]pyridine (PIN)

P-25.3.4.2.4 Choice of locants

If there is a choice of locants, letters, or numerals (consistent with the numbering of the component), the lower letters or numerals are selected in accordance with the following criteria, which are considered in order until a complete decision can be made.

- (a) Parent component letters as a set.

Example:

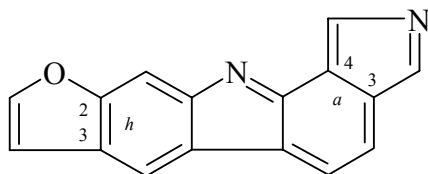

furo[3,2-*h*]pyrrolo[3,4-*a*]carbazole (PIN)
(not furo[2,3-*b*]pyrrolo[3,4-*i*]carbazole;
a,h is lower than *b,i*)

(b) Parent component letters in order of citation.

Examples:

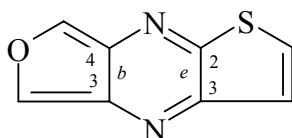

furo[3,4-*b*]thieno[2,3-*e*]pyrazine (PIN)
(not furo[3,4-*e*]thieno[2,3-*b*]pyrazine;
b...e is lower than *e...b*)

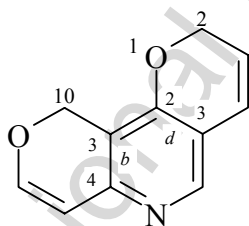

2*H*,10*H*-dipyrano[4,3-*b*:2',3'-*d*]pyridine (PIN)
(not 2*H*,10*H*-dipyrano[2,3-*d*:4',3'-*b*]pyridine;
b...d is lower than *d...b*)

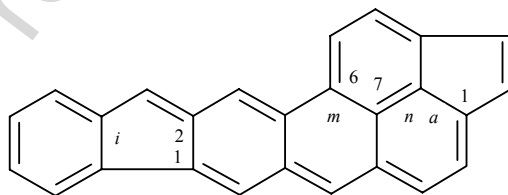

diindeno[1,2-*i*:6',7',1'-*mna*]anthracene (PIN)
(not diindeno[6,7,1-*mna*:1',2'-*i*]anthracene;
i...mna is lower than *mna...i*)

- (c) Set of locants of the first-order attached components for fusion to the parent component.

Example:

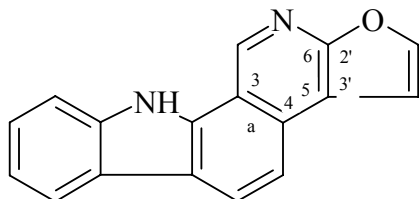

10*H*-furo[3',2':5,6]pyrido[3,4-*a*]carbazole (PIN)
(not 10*H*-furo[2',3':2,3]pyrido[5,4-*a*]carbazole;
the locant set '3,4' is lower than '4,5' for attaching
pyrido to carbazole)

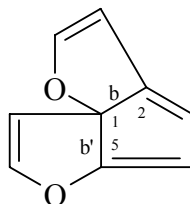

cyclopenta[1,2-*b*:5,1-*b'*]difuran (PIN, a multiparent name)
(not cyclopenta[1,2-*b*:2,3-*b'*]difuran;
the locant set '1,1,2,5' is lower than '1,2,2,3')

- (d) First-order attached component locants for fusion to the parent component in order of citation.

Example:

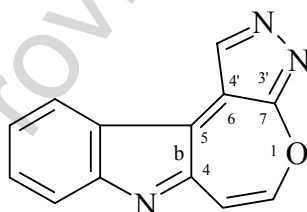

pyrazolo[4',3':6,7]oxepino[4,5-*b*]indole (PIN)
(not pyrazolo[3',4':2,3]oxepino[5,4-*b*]indole;
the locant set '4,5' is lower than '5,4')

- (e) Locants for lower-order attached components as a set for fusion to higher-order attached component.

Example:

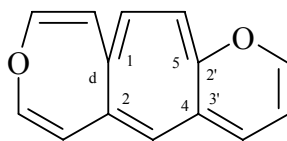

pyrano[3',2':4,5]cyclohepta[1,2-*d*]oxepine (PIN)
(not pyrano[2',3':5,6]cyclohepta[1,2-*d*]oxepine;
the locant set '4,5' is lower than '5,6')

- (f) Locants for lower-order attached components for fusion to higher-order attached components in order of citation.

Example:

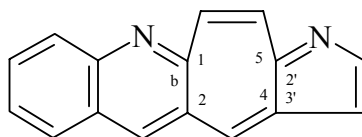

pyrrolo[3',2':4,5]cyclohepta[1,2-*b*]quinoline (PIN)
(not pyrrolo[2',3':5,4]cyclohepta[1,2-*b*]quinoline;
the locant set '4,5' is lower than '5,4')

- (g) Locants for higher-order attached components as a set for fusion to the lower-order attached component.

Example:

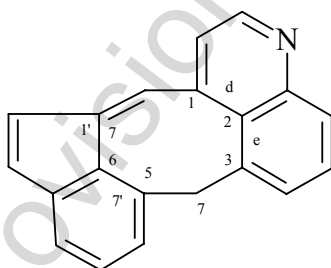

7*H*-indeno[7',1':5,6,7]cycloocta[1,2,3-*de*]quinoline (PIN)
(not 7*H*-indeno[3',4':5,6,7]cycloocta[1,2,3-*de*]quinoline;
the locant set '1,7' is lower than '3,4')

- (h) Locants for higher-order components in fusion to lower order components in order of citation.

Example:

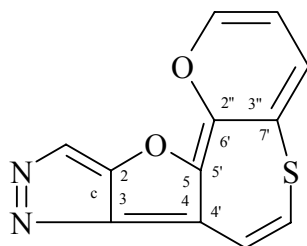

pyrano[2'',3'':6',7']thiophino[4',5':4,5]furo[3,2-*c*]pyrazole (PIN)
(not pyrano[3'',2'':2',3']thiophino[5',4':4,5]furo[3,2-*c*]pyrazole;
the locant set '4',5' ' is lower than '5',4' ')

P-25.3.5 Heteromonocyclic rings fused to a benzene ring as components

Heterobicyclic compounds consisting of a heteromonocycle fused to a benzene ring in which the benzene ring is not part of a system having a retained name such as quinoline or naphthalene are treated as a single component unit (a 'benzoheterocycle', see P-25.2.2.4). They may be treated as a parent component or an attached component depending on the order of seniority described in P-25.3.2.4. However, this approach is not to be used if it disrupts a multiparent system (see P-25.3.5.3, below) or the use of multiplicative prefixes (see P-25.3.6.1, below).

P-25.3.5.1 A benzoheterocycle as a parent component

Example:

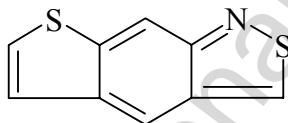

thieno[3,2-*f*][2,1]benzothiazole (PIN)
(2,1-benzothiazole is senior to 1-benzothiophene)

P-25.3.5.2 A more senior component as parent component

Example:

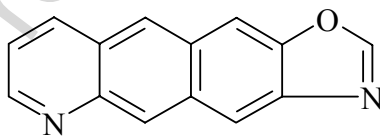

[1,3]benzoxazolo[6,5-*g*]quinoline (PIN)
(quinoline is senior to 1,3-benzoxazole)

P-25.3.5.3 A multiparent name is preferred to a fused system, when there is a choice.

Example:

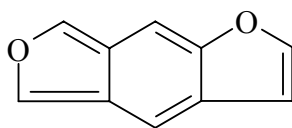

benzo[1,2-*b*:4,5-*c'*]difuran (PIN)
(not furo[3,4-*f*][1]benzofuran;
a multiparent name is preferred to a
two component fused name)

P-25.3.5.4 Retained names are senior to names of benzoheterocycles

Examples:

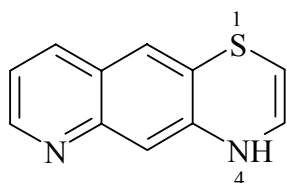

4*H*-[1,4]thiazino[2,3-*g*]quinoline (PIN)
(the retained name quinoline
must be used)

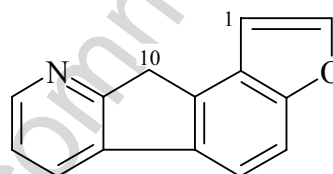

10*H*-furo[3',2'-4,5]indeno[2,1-*b*]pyridine (PIN)
(not [1]benzofuro[5',4':3,4]cyclopenta-
[1,2-*b*]pyridine; pyridine is senior to
furan; indene, as a retained name, must
be used)

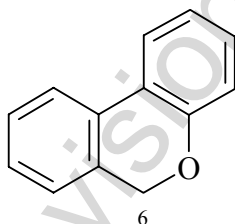

6*H*-benzo[*c*]chromene (PIN)
(not 6*H*-benzo[*c*][1]benzopyran; the retained name
chromene must be used; not 6*H*-benzo[*b,d*]pyran;
chromene is the larger parent component]

P-25.3.6 Treatment of identical attached components

P-25.3.6.1 Two or more components that are identical and both fused to a parent component are indicated by the use of multiplying prefixes (di-, tri-, etc. or bis-, tris-, etc.). If a complete set of locants is used for first order attached components fused to the parent component, they are cited together separated by a colon. If abbreviated sets of locants are used, the letters are separated by a comma. If complete sets of locants are used for second order attached components fused to a first order attached component, or for higher order cases, the locants are cited together separated by a semicolon. If abbreviated sets are used, they are separated by a colon. To

distinguish between two or more components of the same order, the locants of the second component are primed (or double primed if the first is primed, etc.), the third double primed, and so on.

Examples:

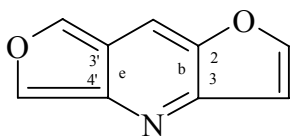

difuro[3,2-*b*:3',4'-*e*]pyridine (PIN)

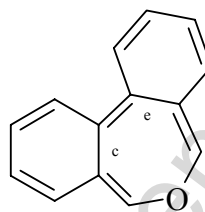

dibenzo[*c,e*]oxepine (PIN)

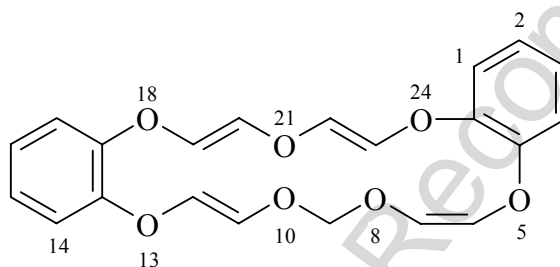

dibenzo[*g,p*][1,3,6,9,12,15,18]heptaoxacycloicosine (PIN)

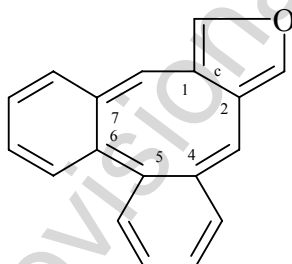

dibenzo[4,5:6,7]cycloocta[1,2-*c*]furan (PIN)

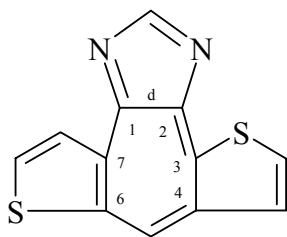

dithieno[2',3':3,4;2'',3'':6,7]cyclohepta[1,2-*d*]imidazole (PIN)

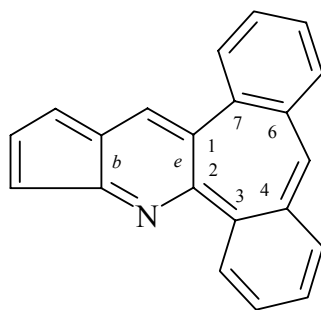

cyclopenta[*b*]dibenzo[3,4:6,7]cyclohepta[1,2-*e*]pyridine (PIN)

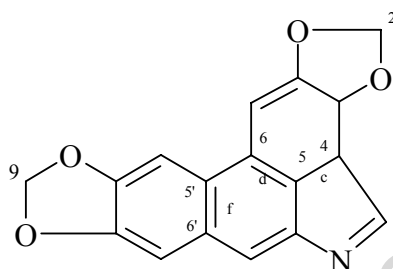

2*H*,9*H*-bis[1,3]benzodioxolo[4,5,6-*cd*:5',6'-*f*]indole (PIN)

P-25.3.6.2 Additional components attached to a system with a multiplicative prefix.

Fusion of a higher order attached component to a system named with a multiplicative prefix requires each set of attached components to be specified separately.

Example:

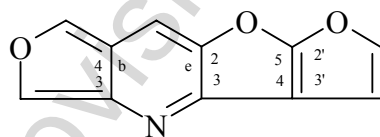

furo[3,4-*b*]furo[3',2':4,5]furo[2,3-*e*]pyridine (PIN)

P-25.3.6.3 Groups of identical components with identical fusion locants.

Two or more groups of identical components (including identical fusion locants between these components) fused to another component, are indicated by the use of the multiplying prefixes bis-, tris-, etc., and the group of components is cited within parentheses.

Example:

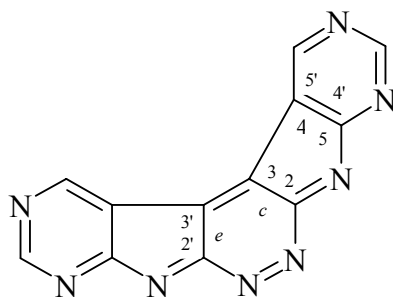

bis(pyrimido[5',4':4,5]pyrrolo)[2,3-c:3',2'-e]pyridazine (PIN)

P-25.3.7 Multiparent systems

Two or more nonoverlapping locations for parent components that are *ortho*- or *ortho*- and *peri*-fused to the same first-order interparent component are treated as a multiparent system and given a multiparent name. Similarly a system with three, five, seven, etc. interparent components is treated as an extended multiparent system. Each pair of second or higher order interparent components must be identical.

P-25.3.7.1 Multiparent systems with one interparent component

Multiple occurrences of the parent component in a multiparent system are indicated by the use of a multiplying prefix ('di', 'tri', etc. or 'bis', 'tris', etc.). To distinguish between the parent components the second parent component, has primed letters, the third double primed, etc.; the sets of locants are separated by a colon.

Examples:

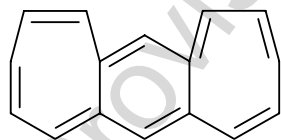

benzo[1,2:4,5]di[7]annulene (PIN)

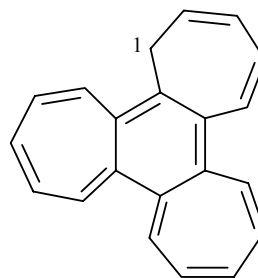

1H-benzo[1,2:3,4:5,6]tri[7]annulene (PIN)

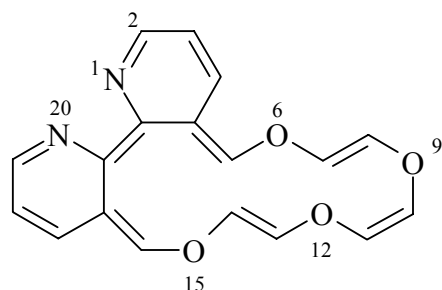

[1,4,7,10]tetraoxacyclohexadecino[13,12-*b*:14,15-*b'*]dipyridine (PIN)

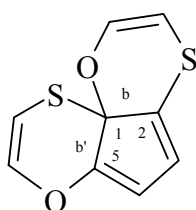

cyclopenta[1,2-*b*:5,1-*b'*]bis[1,4]oxathiazine (PIN)

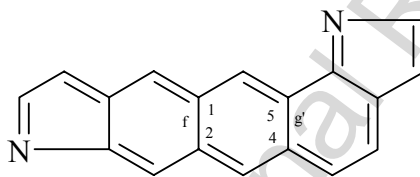

benzo[1,2-*f*:4,5-*g'*]diindole (PIN)

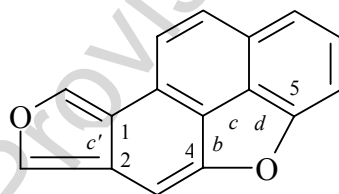

phenanthro[4,5-*bcd*:1,2-*c'*]difuran (PIN)

P-25.3.7.2 Additional attached components

Additional attached components may be fused to any of the components of a multiparent system. If the choice of locants described in P-24.4.5.2.4 does not permit a final choice, seniority is given to the unprimed component and the fusion letters are assigned with the lower letter used for fusion to the connecting component. Great care is needed with the use of primes, double

primes, etc. to ensure that there is no ambiguity. Thus additional components fused to the interparent component(s) are cited next to the prefix for the interparent component.

Examples:

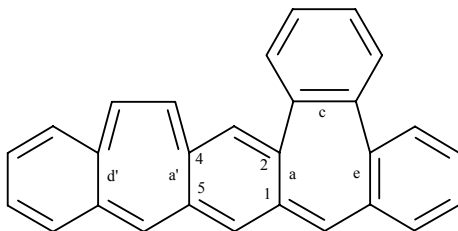

tribenzo[*c,d',e*]benzo[1,2-*a*:4,5-*a'*]di[7]annulene (PIN)

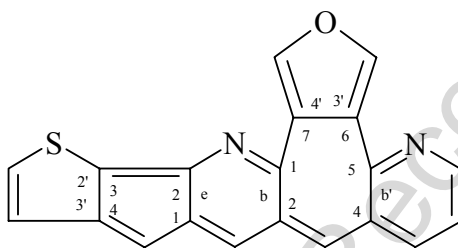

thieno[2',3':3,4]cyclopenta[1,2-*e*]furo[3',4':6,7]cyclohepta[1,2-*b*:5,4-*b'*]dipyridine (PIN)
(the furan ring is fused to the interparent component; thus, alphabetical order does not apply)

P-25.3.7.3 Multiparent systems with three or more interparent components

When two (or more) possible parent components are separated by an odd number of interparent components and these are ordered symmetrically with respect to their component rings (but not necessarily with their fusion locants), the whole system is treated as a multiparent system. Second and higher-order interparent components are named using the multiplying prefixes 'di', 'tri', etc. or 'bis', 'tris', etc. Two methods are to be considered. Method (a) generates IUPAC preferred names.

- This method is extended to all compounds, with appropriate locants assigned to interparent components, unprimed and primed for first-order interparent components, double primed for second-order interparent components, tripled primed for third-order interparent components, and so on.
- When symmetry permits grouping of interparent components and parent components, such groups can be formed and cited as such using the multiplying prefixes 'bis', 'tris', etc. to denote groups that are enclosed within parentheses. Unprimed locants only are used within such groupings.

Examples:

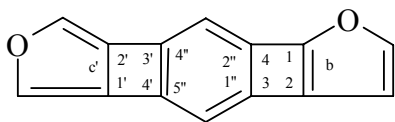

(a) benzo[1'',2'':3,4;4'',5'':3',4']dicyclobuta[1,2-*b*:1',2'-*c*']difuran (PIN)

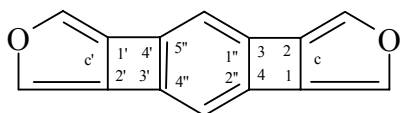

(a) benzo[1'',2'':3,4;4'',5'':3',4']dicyclobuta[1,2-*c*:1',2'-*c*']difuran (PIN)

(b) benzo[1'',2'':3,4;4'',5'':3',4']bis(cyclobuta[1,2-*c*]furan)

P-25.3.8 Omission of locants

P-25.3.8.1 When there is no ambiguity, numerical and/or letter locants may be omitted in a system with only first order attached components.

Examples:

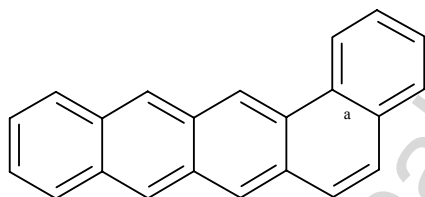

benzo[*a*]tetracene (PIN)

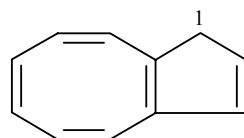

1*H*-cyclopenta[8]annulene (PIN)

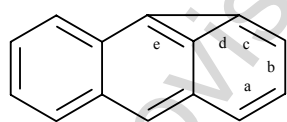

cyclopropa[*de*]anthracene (PIN)

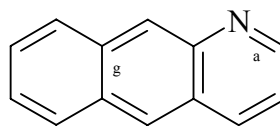

benzo[*g*]quinoline (PIN)

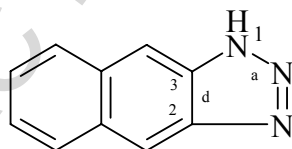

1*H*-naphtho[2,3][1,2,3]triazole (PIN)

P-25.3.8.2 Locants are also omitted when there is no ambiguity for the fusion of a terminal attached component.

Example:

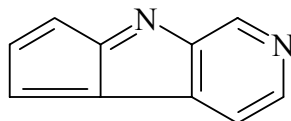

cyclopenta[4,5]pyrrolo[2,3-*c*]pyridine (PIN)

P-25.3.8.3 When locants are required for the fusion of a higher-order component then all locants for linking components must be cited.

Example:

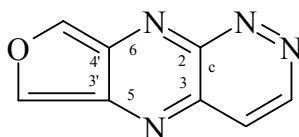

furo[3',4';5,6]pyrazino[2,3-*c*]pyridazine (PIN)

P-25.3.8.4 The numerical locants of peripheral fusion carbon atoms of a component are omitted with an *ortho*- and *ortho*- and *peri*-fused system.

Examples:

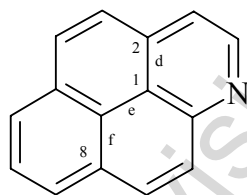

naphtho[2,1,8-*def*]quinoline (PIN)

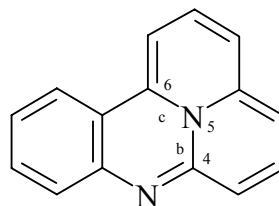

quinolizino[4,5,6-*bc*]quinazoline (PIN)

Both terminal fusion atom locants for *ortho*-fusion must be cited even if one is a fusion atom.

Example:

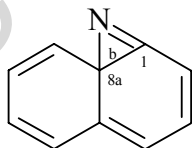

naphtho[1,8a]azirine (PIN)

P-25.4 Bridged fused systems

This Section is based on the publication 'Nomenclature of Fused and Bridged Fused Ring Systems' (ref. 4). It deals mainly with naming bridged fused ring systems having only independent bridges. For naming bridged fused ring systems having dependent bridges, consult the full publication (ref. 4).

- P-25.4.1 Definitions and terminology
- P-25.4.2 Names for bridges
- P-25.4.3 Procedure for naming bridged systems
- P-25.4.4 Naming bridged fused systems
- P-25.4.5 Numbering bridge atoms
- P-25.4.6 Order for numbering of bridges

P-25.4.1 Definitions and terminology

P-25.4.1.1 Bridged fused ring system. A ring system in which some of the rings constitute a fused ring system (see P-25.0 - P-25.3) and the remaining rings are created by one or more bridges.

P-25.4.1.2 Bridge. An atom or group of atoms is named as a bridge by means of a prefix if it fulfills one or more of the following:

- (a) if it connects two or more non-adjacent positions of the same ring in a fused ring system;
- (b) if it connects two or more positions of different rings of a fused ring system and does not thereby form a new *ortho*- and *peri*-fused ring;
- (c) if it connects positions of a ring of a fused ring system to a previously described bridge but cannot be included as part of that bridge;
- (d) if it connects the atoms at the end of a bond common to two rings of a fused ring system;
- (e) if it is used to describe a system with only *ortho*- or *ortho*- and *peri*-fusions that cannot be named entirely by fusion principles.

Examples (bridges are indicated in bold):

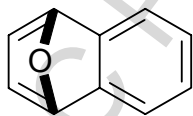

criterion (a)

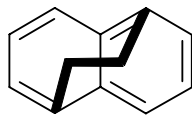

criterion (b)

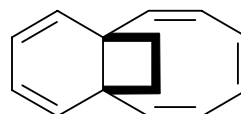

criterion (d)

P-25.4.1.3 Bridgehead atom. An atom of a fused ring system to which a bridge is attached.

P-25.4.1.4 Simple bridge prefix. A bridge that describes an atom, or groups of atoms, that may be described as a single unit, e.g., 'epoxy', 'butano', 'benzeno'.

P-25.4.1.5 Composite bridge. A group of atoms that can only be considered as a contiguous sequence of simple bridges, e. g., (epoxymethano) = epoxy + methano = $-\text{O}-\text{CH}_2-$.

P-25.4.1.6 Bivalent bridge. A bridge that is connected by single bonds to two different positions of a fused ring system or bridged fused ring system. All bridges described in P-25.4.2.1 are simple bridges.

P-25.4.1.7 Polyvalent bridge. A bridge that is connected to a fused ring system by three or more single bonds or their multiple bond equivalent. Polyvalent bridges may often be described by a combination of two simple bivalent bridges. Polyvalent bridges may be further classified as bipodal, tripodal, etc., when the bridge is attached to two, three, or more positions of the fused ring system.

Examples:

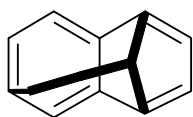

a tripodal bridge

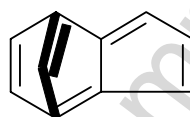

a bipodal bridge

P-25.4.1.8 Independent bridge. A bridge that only connects two or more positions of a fused ring system (see dependent bridge).

P-25.4.1.9 Dependent bridge. A bridge that connects one or more positions of a fused ring system to one or more positions of a simple or composite independent bridge, and cannot be expressed as part of a larger composite bridge.

Example:

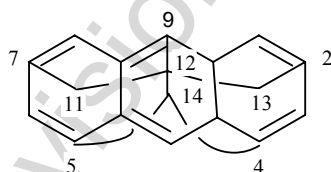

4,5,12-epimethanetriyl-2,9,7-epipropane[1,2,3]triyllanthracene (PIN)
(the epimethanetriyl bridge C-14 is a dependent bridge;
the epipropane[1,2,3]triyyl bridge at C-11 to C-13 is an
independent bridge)

P-25.4.2 Names of bridges

The extensive list of bridge names given in the publication on fused ring and bridged fused ring nomenclature (ref. 4) has been carefully reviewed and updated in the context of the recommendations given herein. Most of the changes occurred in the names of acyclic heteroatom bridge names (see P-25.4.2.1.4)

P-25.4.2.1 Bivalent bridges.

P-25.4.2.1.1 A bivalent acyclic hydrocarbon bridge is named as a prefix derived from the corresponding rectilinear hydrocarbon name by changing the final letter 'e' to 'o'. The locant for a double bond, if present, is indicated in square brackets between the hydrocarbon prefix and the ending 'eno'; this locant is not the locant used in the final numbering of the bridged fused ring system (see P-25.4.4). If there is a choice low numbers are preferred (e.g., prop[1]eno rather than prop[2]eno).

Examples:

methano (PIN)	-CH ₂ -
ethano (PIN)	-CH ₂ -CH ₂ -
propano (PIN)	-CH ₂ -CH ₂ -CH ₂ -
etheno (PIN)	-CH=CH-
prop[1]eno (PIN)	-CH=CH-CH ₂ -
but[1]eno (PIN)	-CH=CH-CH ₂ -CH ₂ -
but[2]eno (PIN)	-CH ₂ -CH=CH-CH ₂ -
buta[1,3]dieno (PIN)_	-CH=CH-CH=CH-

P-25.4.2.1.2 A bivalent monocyclic hydrocarbon bridge other than benzene is named by the same prefix as that used as a fusion prefix (P-25.3.2.2). To distinguish between these two, 'epi' is added in front of the name when used as a bridge prefix; the letter 'i' in the prefix 'epi' is elided before the letters 'i' and 'o' of the following term. The bridge is assumed to have the maximum number of noncumulative double bonds consistent with its attachments to the fused ring system or to other bridges. The positions of the free valences of the bridge are indicated by locants in square brackets cited directly in front of the bridge name; these locants are not those used for bridge atoms in the final structure. Locants for indicated hydrogen atoms, if present, are those for the final structure and are cited in front of the completed name.

Examples:

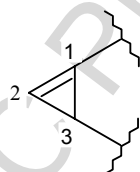

[1,3]epicyclopropa (PIN)

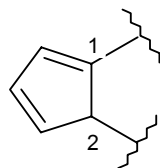

[1,2]epicyclopenta (PIN)

P-25.4.2.1.3 Bivalent cyclic hydrocarbon bridges not named in P-25.4.2.1.2 are named as a prefix derived from the corresponding hydrocarbon name by replacing the terminal letter 'e' by 'o'. If the name of the bridge is the same as the name of the fusion prefix, the bridge prefix is distinguished by the prefix 'epi-'. The letter 'i' is elided if followed by a vowel. Locants are used in the same way as described in section P-25.4.2.1.2.

Examples:

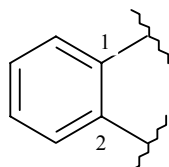

[1,2]benzeno (PIN)
 (not [1,2]benzo)

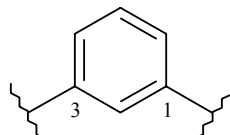

[1,3]benzeno (PIN)
 (not [1,3]benzo)

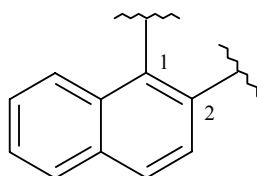

[1,2]naphthaleno (PIN)
 (not epi[1,2]naphtho; naphtho
 is the name of a fusion prefix)

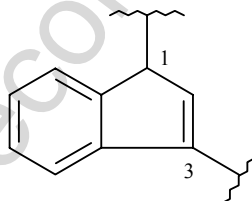

[1,3]epindeno (PIN)

P-25.4.2.1.4 A bivalent acyclic homogeneous heteroatom bridge is named by an appropriate prefix based either on a substitutive prefix name or the name of the corresponding parent hydride. Bridge prefixes based on a substitutive prefix, in use today or formerly recommended, are distinguished by the prefix 'epi' (or 'ep' before the letter 'i' or 'o' of the following term). Bridge prefixes based on the name of a parent hydride are named in the same way as for acyclic hydrocarbon bridge prefixes (see P-25.4.2.1.1). Heteroatoms with nonstandard bonding numbers are described by the λ -convention (see P-14.1).

Examples:

epoxy (PIN)	–O–	azano (not epimino)	–NH–
epidioxo (PIN)	–OO–	epidiazano (PIN)	–NHNH–
epitrioxo (PIN)	–OOO–	epidiazeno (PIN)	–N=N–
sulfano (PIN)	–S–	epitriazano (PIN)	–NHNHNH–
λ^4 -sulfano (PIN)	–SH ₂ –	(epitriaz[1]eno) (PIN)	³ –NH– ² N= ¹ N–

disulfano (PIN)	–SS–	phosphano (PIN)	–PH–
selano (PIN) (not episeleno)	–Se–	silano(PIN)	–SiH ₂ –
tellano (PIN)	–Te–	borano (PIN)	–BH–

P-25.4.2.1.5 A bivalent heterocyclic bridge is named as a prefix derived from the corresponding heterocyclic compound by adding a letter ‘o’ with elision of a final letter ‘e’ if present. If the heterocyclic system requires the citation of locants, these are given in square brackets in front of the name of the prefix. If the name of the bridge is the same as the fusion prefix, the bridge prefix is distinguished by the prefix ‘epi’ (or ‘ep’ before the letter ‘i’ or ‘o’ of the following term).

Examples:

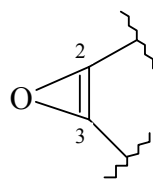

epoxireno (PIN)

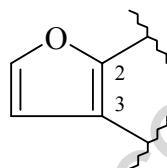

[2,3]furano (PIN)
(not epi[2,3]furano)

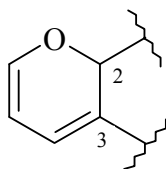

[2,3]epipyrano (PIN)

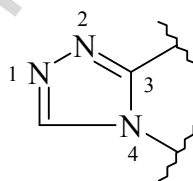

[3,4]epi[1,2,4]triazolo (PIN)

P-25.4.2.2 Polyvalent bridges

P-25.4.2.2.1 A polyvalent bridge consisting of one atom (other than hydrogen) is named by an appropriate prefix based either on a substitutive prefix name or the name of the corresponding parent hydride. Polyvalent bridges are enclosed by parentheses in names of bridged fused systems; as a reminder, parentheses are placed around the names of the bridges themselves in the examples below). For ‘epi’, see P-25.4.2.1.4.

Examples:

(metheno) (PIN)	–CH=	(epimethanetriyl) (PIN)	$\begin{array}{c} \\ -CH- \end{array}$
(epimethanediylidene) (PIN)	$\begin{array}{c} \\ -C= \end{array}$	(epiazanediyl) (PIN) (not epimino)	–NH–

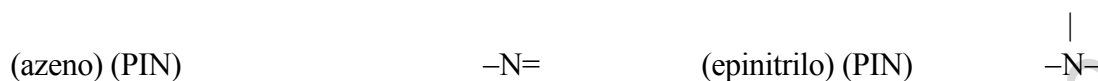

P-25.4.2.2.2 A polyvalent polyatomic bridge is named as the appropriate polyvalent substituent group and enclosed in parentheses in names (as a reminder, parentheses are placed around the names of the bridges themselves in the examples below). If necessary, the positions of the free valences are indicated by appropriate locants cited directly in front of the associated ending. The suffix 'ylidene' is restricted to those cases in which there is a double bond between the bridge and the fused system. When there is a choice of numbering the bridge, preference is given to (a) the suffix 'yl', (b) the suffix 'ylidene', (c) double bonds. For 'epi', see P-25.4.2.1.4.

Examples:

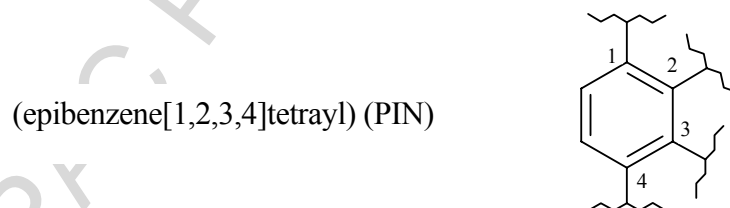
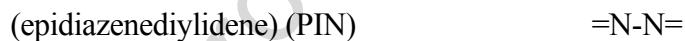
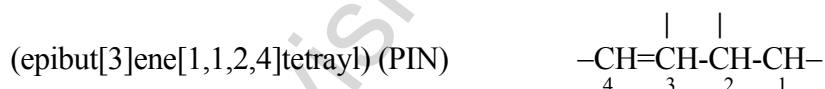
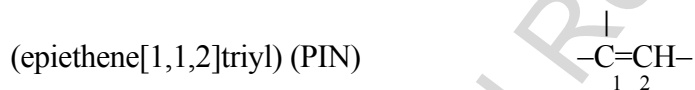
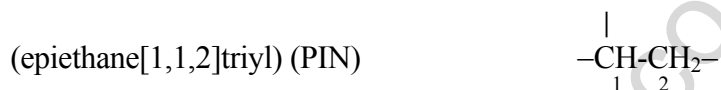

P-25.4.2.3 Composite bridges

Composite bridge names are formed by combining the names of two or more simple bridges. Unless cited first, the prefix 'epi' (or 'ep' before the letter 'i' or 'o' of the following term.) is omitted. The prefixes are cited in order starting from the terminal prefix with a heteroatom appearing first in the list: O > S > Se > Te > N > P > As > Sb > Bi > Si > Ge > Sn > Pb > B > Al > Ga > In > Tl. Then alphabetical order is used. Composite bridges are enclosed within parentheses in names of bridged fused compounds; as a reminder, parentheses are placed around the names of bridges themselves.

Examples:

(epoxymethano) (PIN) $\text{-O-CH}_2\text{-}$

(azanoethano) (PIN) $\text{-NH-CH}_2\text{-CH}_2\text{-}$

(epoxysulfanoxy) (PIN) -O-S-O-

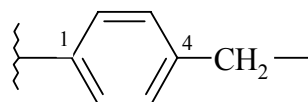

([1,4]benzenomethano) (PIN)

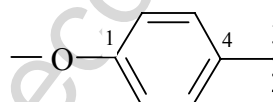

(epoxy[1,4]benzeno) (PIN)

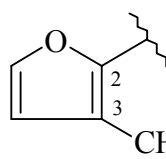

([2,3]furanomethano) (PIN)

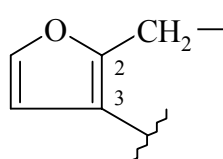

([3,2]furanomethano) (PIN)

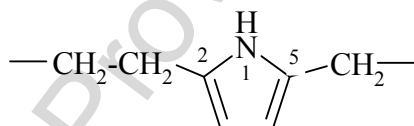

(ethano[2,5]pyrrolomethano) (PIN)

P-25.4.3 Procedure for naming bridged fused ring systems

P-25.4.3.1 Selection of bridge

When a polycyclic ring system cannot be named completely as a fused ring system, possible ways for naming it as a bridged fused system are considered. Bridges are selected so that a recommended fused ring system as described in P-25.4.2.3 is obtained.

P-25.4.3.2 Naming of *ortho*- or *ortho*- and *peri*-fused systems

The ring system that remains after removal of the bridge(s) is named following P-25.1 through P-25.3. The maximum number of noncumulative double bonds is assigned after the insertion of the bridge. Hence, in order to allow for the necessary free valences to the bridge, the fused ring system may differ from the isolated ring system in the number of noncumulative double bonds and/or the need for indicated hydrogen. If needed, indicated hydrogen is used to identify the required isomer and is cited in front of the completed bridged fused ring name.

Examples:

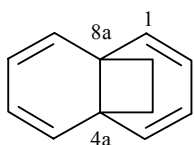

4a,8a-ethanonaphthalene (PIN)

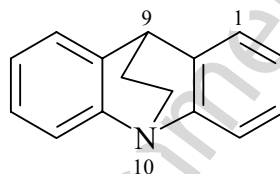

9H-9,10-ethanoacridine (PIN)

P-25.4.3.3 Selection of fused ring system to be bridged

If there is a choice for selecting the fused ring system to be bridged, the criteria in the following list are applied in order until a complete decision is reached. The fused ring system, before bridging must:

- (a) contain the maximum number of rings.

Examples:

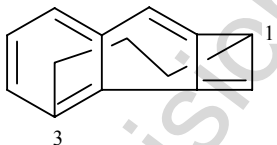

1H-1,3-propanocyclobuta[*a*]indene (PIN)

correct

not

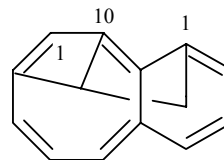

8,10,1-epiethane[1,1,2]triylobenzo[8]annulene

incorrect

(the correct name has three rings in the fused system; the incorrect name has only two rings in the fused system)

- (b) include the maximum number of skeletal atoms

Example:

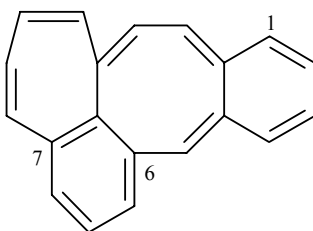

6,7-epiprop[1]en[1]yl[3]ylidenebenzo[*a*]cyclohepta[*e*][8]annulene (PIN)
 (not 4,5-buta[1,3]dienodibenzo[*a,d*][8]annulene)

(the fused ring system benzo[*a*]cyclohepta[*e*][8]annulene has 17 atoms
 whereas the fused ring system dibenzo[*a,d*][8]annulene has only 16 atoms)

(c) contain the minimum number of heteroatoms in the fused ring system.

Example:

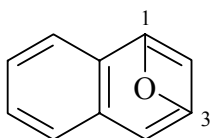

1,3-epoxynaphthalene (PIN)

correct

not

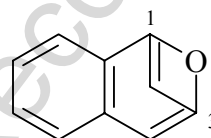

1,3-methenoisochromene

incorrect

(the correct name has no heteroatoms in the fused system; the
 incorrect one has one hetero atom in its fused system)

(d) consist of the most senior ring system, when the seniority order is applied to the whole fused ring system (see P-44.2):

Example:

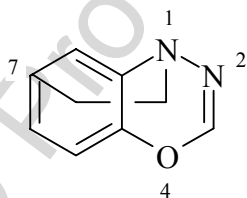

1,7-ethano[4,1,2]benzoxadiazine (PIN)

correct

not

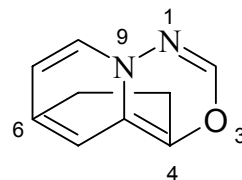

4,6-ethanopyrido[1,2-*d*][1,3,4]oxadiazine

incorrect

(in the correct two-ring system, the locant set 1,2,4 for heteroatoms
 is lower than 1,3,9)

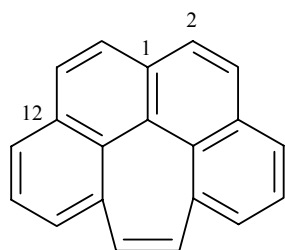

not

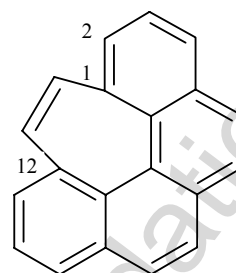

1,12-ethenobenzo[4,5]cyclohepta[1,2,3-*de*]naphthalene (PIN) 1,12-ethenobenzo[*c*]phenanthrene

correct

incorrect

(in the correct name the ring size set 7,6,6,6 is preferred to 6,6,6,6)

(e) have the minimum number of composite bridges:

Examples:

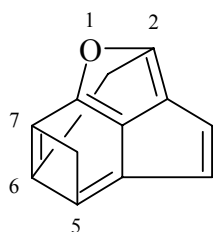

not

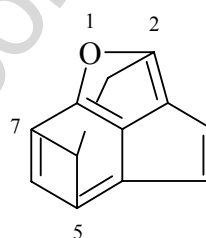

2,6:5,7-dimethanoindeno[7,1-*bc*]furan (PIN)

5,7,2-epiethane[1,1,2]triylindeno[7,1-*bc*]furan

correct

incorrect

(the correct name has no composite bridges; the incorrect name has one composite bridge)

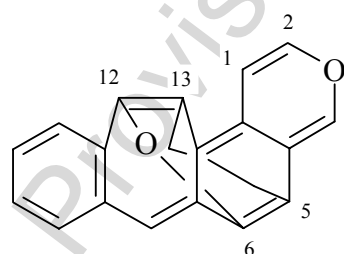

not

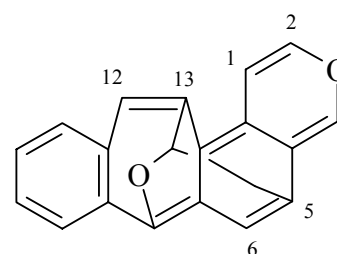

6,12-epoxy-5,13-methanobenzo[4,5]cyclo[1,2-*f*]isochromene (PIN)

7,5,13-(epoxyepimethanetriyl)benzo[4,5]cyclohepta[1,2-*f*]isochromene

correct

incorrect

(the correct name has no composite bridges; the incorrect name has one)

(f) have the minimum number of dependent bridges:

Example:

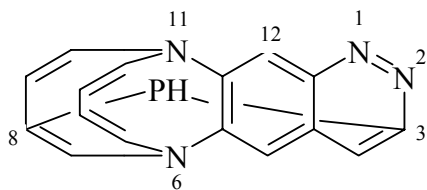

6,11-buta[1,3]dieno-3,8-phosphano[1,4]-
 diazocino[2,3-g]cinnoline (PIN)

correct

not

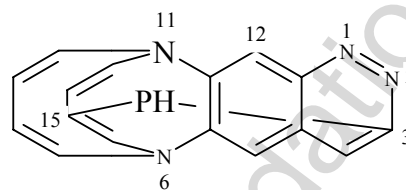

3,14-phosphano-6,11-buta[1,3]dieno[1,4]-
 diazocino[2,3-g]cinnoline

incorrect

(the correct name has no dependent bridges; the incorrect name has one dependent bridge)

(g) have the minimum number of atoms in dependent bridges:

Example:

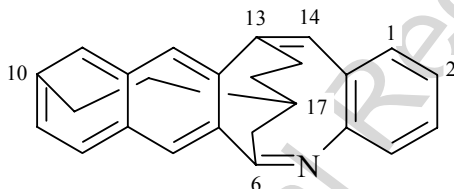

6,17-methano-10,13-pentanaphtho[2,3-c][1]benzazocine (PIN)
 (not 13,17-ethano-6,10-butanonaphtho[2,3-c][1]benzazocine)
 (not 10,17-ethano-6,13-butanonaphtho[2,3-c][1]benzazocine)

(the correct name has only one atom in a dependent bridge)

(h) have the maximum number of bivalent bridges; thus 'diyl' is senior to 'ylylidene', 'triylyl', diylidene', 'diylylidene', or 'tetraylyl', etc. Similarly 'ylylidene' is senior to 'triylyl', etc..

Examples:

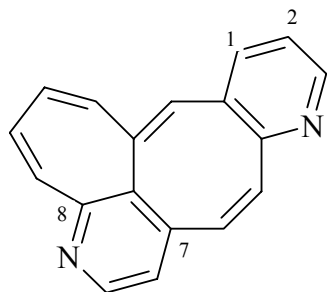

8,7-(azenoetheno)cyclohepta[4,5]cyclo-
octa[1,2-*b*]pyridine (PIN)

correct

not

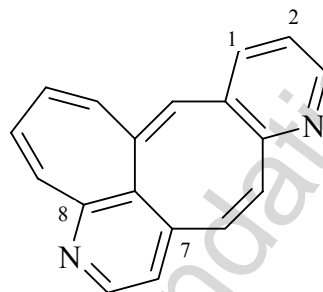

8,7-(azanoethanediylidene)cyclohepta-
[4,5]cycloocta[1,2-*b*]pyridine

incorrect

(the correct name has a composite bridge consisting of a trivalent bridge and a divalent bridge name whereas the composite bridge in the incorrect name consists of a trivalent bridge name and a tetravalent bridge name)

- (i) have the lowest locants at the location of bridges, first for independent bridges then dependent bridges.

Example:

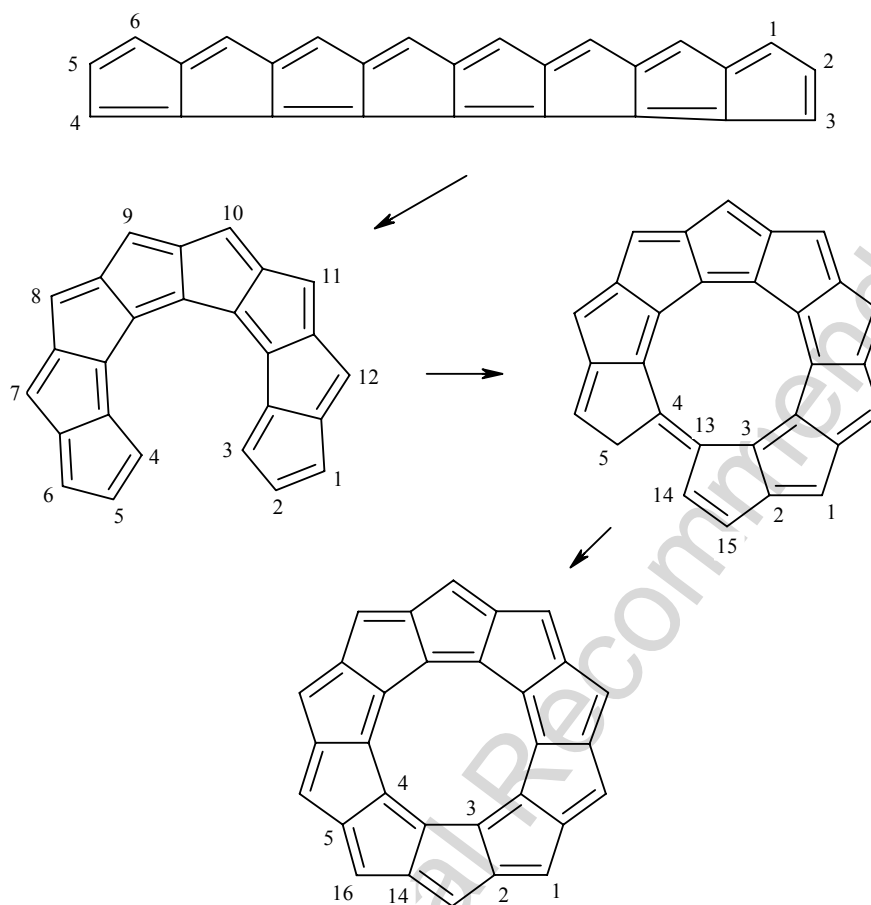

5,14-(metheno)-2,3,4-epirop[2]ene[1,3]diyl[1]ylidenedicyclopenta[*f,f'*]-
 pentaleno[1,2-*a*:6,5-*a'*]dipentalene (PIN)
 [not 5,14-(metheno)-2,4,3-epirop[2]ene[1,3]diyl-[1]ylidenedicyclo-
 penta[*f,f'*]pentaleno[1,2-*a*:6,5-*a'*]dipentalene)
 (the locants '2,3,4' for the independent bridge are lower than '2,4,3')

(j) have the maximum number of noncumulative double bonds in the parent ring system.

Example:

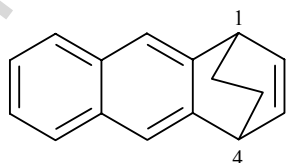

1,4-dihydro-1,4-ethanoanthracene (PIN)
 (not 1,2,3,4-tetrahydro-1,4-ethanoanthracene)

P-25.4.4 Naming bridged fused ring systems

P-25.4.4.1 Order of citation of first order bridges

P-25.4.4.2 Attachment locants

P-25.4.4.3 Choice of attachment locants

P-25.4.4.4 Treatment of identical bridges

P-25.4.4.1 Order of citation of first order bridges

If there is more than one bridge, they are cited in alphabetical order, unless one is dependent on another. In this case, the dependent bridge is cited in front of all independent bridges.

P-25.4.4.2 Attachment locants

The fused ring system is numbered in the usual way.

P-25.4.4.2.1 Symmetric bridges

The locants of the positions on the fused ring system to which the bridge(s) is (are) attached are cited in numerical order in front of the bridge name:

Example:

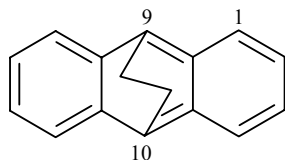

9,10-methanoanthracene (PIN)

P-25.4.4.2.2 Asymmetric bridges

The locants of the positions on the fused ring system to which the bridge is attached are cited in the order implied by the name of the asymmetric bridge (locant order for the free valences of the bridge is given in section P-25.4.1). If there is a choice, locants are cited in numerical order. Indicated hydrogen atoms are cited at the front of the name.

Examples:

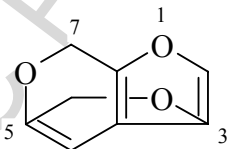

7H-3,5-(epoxymethano)furo[2,3-*c*]pyran (PIN)

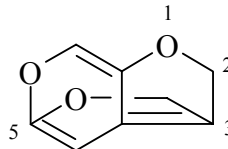

2H-5,3-(epoxymethano)furo[2,3-*c*]pyran (PIN)

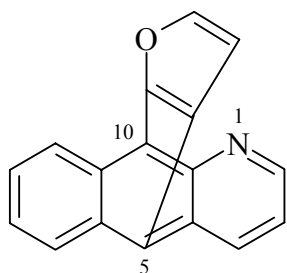

10,5-[2,3]furanobenzo[g]quinoline (PIN)

P-25.4.4.3 Choice of attachment locants

If there is a choice of attachment locants after the application of P-25.4.4.2, seniority is established in the following order:

- (a) the lowest set of locants for all the bridge attachment points considered as a set.

Examples:

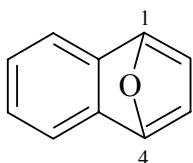

1,4-epoxynaphthalene (PIN)
(not 5,8-epoxynaphthalene)

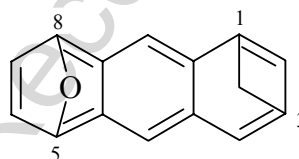

5,8-epoxy-1,3-methanoanthracene (PIN)
(not 1,4-epoxy-5,7-methanoanthracene)
(the set 1,3,5,8 is lower than 1,4,5,7)

- (b) lowest locants in the order of citation for the bridges:

Examples:

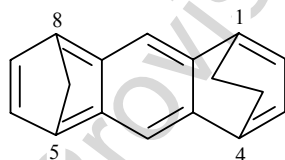

1,4-ethano-5,8-methanoanthracene (PIN)

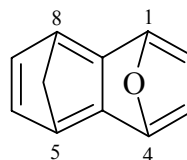

1,4-epoxy-5,8-methanonaphthalene (PIN)

P-25.4.4.4 Identical bridges

Two or more identical bridges are indicated by the numerical prefixes 'di', 'tri', etc. with single bridges, or 'bis', 'tris', etc. with composite bridges or if 'di', 'tri', etc. would be ambiguous. The locant pairs of the bridges are separated by colons.

Examples:

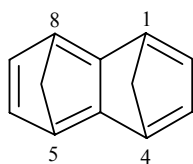

1,4:5,8-dimethanonaphthalene (PIN)

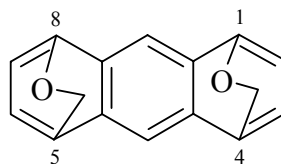

1,4:8,5-bis(epoxymethano)anthracene (PIN)

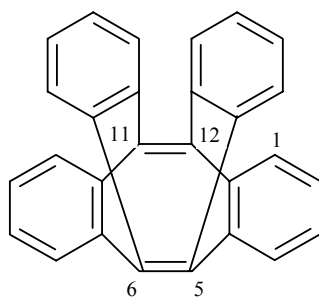

5,12:6,11-di[1,2]benzenodibenzo[*a,e*][8]annulene (PIN)

P-25.4.5 Numbering of bridge atoms

Bridge atoms are numbered continuing from the highest locant of the fused ring system. If there is more than one bridge atom (excluding hydrogen) the numbering starts at the end of the chain or ring atom connected to the bridgehead of the fused ring system having the highest locant. With composite bridges, each component is completely numbered before the next component. Fusion atoms in fused ring bridges are numbered in accordance with P-25.3.3.1.1.

Example:

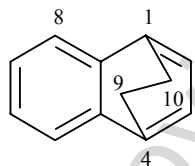

1,4-ethanonaphthalene (PIN)

P-25.4.5.1 When there is a choice of locants, lowest locants are assigned according to the following criteria, in order, until a definitive decision is reached.

- low locants for heteroatoms;
- low locants for bridgehead atoms within a bridge;
- number the remaining atoms (excluding hydrogen) consecutively.

Examples:

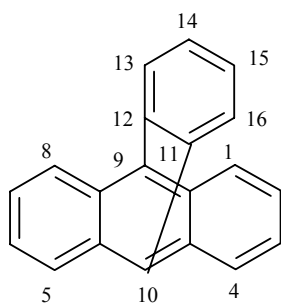

9,10-[1,2]benzenoanthracene (PIN)

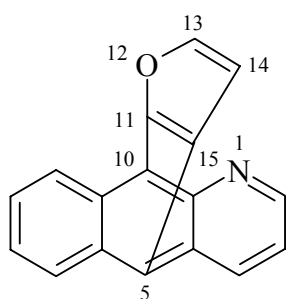

10,5-[2,3]furanobenzo[g]quinoline (PIN)

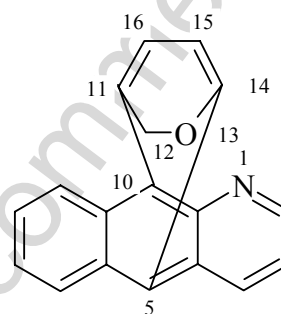

12H-2,10-[2,5]epipyranobenzo[g]quinoline (PIN)

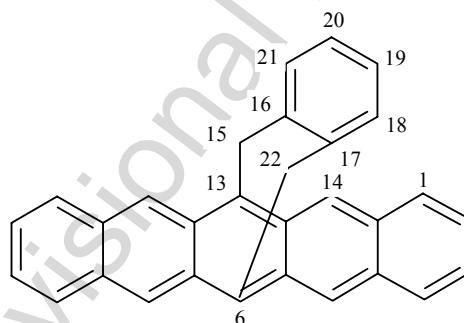

6,13-(methano[1,2]benzenomethano)pentacene (PIN)

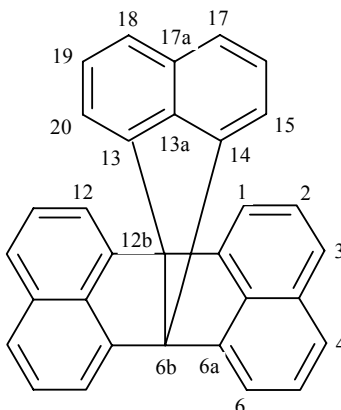

6b,12b-[1,8]naphthalenoacenaphthylene[1,2-*a*]acenaphthylene (PIN)
(locants 13a and 17a are generated in conformity with P-25.3.3.1.1)

P-25.4.6 Order for numbering bridges

P-25.4.6.1 Independent bridges are numbered before dependent bridges.

Example:

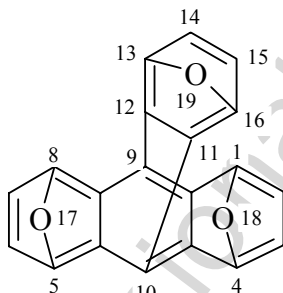

13,16-epoxy-1,4:5,8-diepoxy-9,10-[1,2]benzenoanthracene (PIN)
(dependent bridges are cited before independent bridges but are numbered after them)

P-25.4.6.2 If there is more than one bridge of the same type (dependent or independent), seniority is given to the bridge attached to the bridgehead with the higher locant at the first point of difference.

Examples:

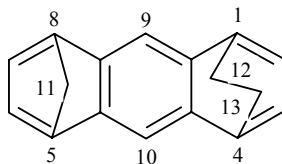

1,4-ethano-5,8-methanoanthracene (PIN)

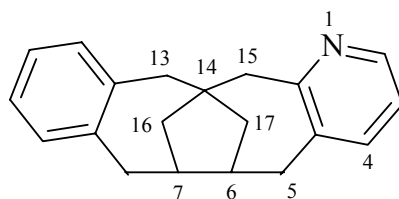

6,14:7,14-dimethanobenzo[7,8]cycloundeca[1,2-b]pyridine (PIN)

P-25.4.6.3 If two bridges are attached to the same bridgehead atoms, they are numbered in accordance with their order of citation.

Example:

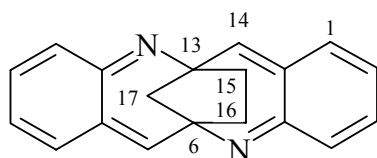

6,13-ethano-6,13-methanodibenzo[*b,g*][1,6]diazecine (PIN)

P-25.5 Limitations of fusion nomenclature

The fusion principles described in P-25.1 through P-25.3 apply only between pairs of components. It is not possible by these principles to name a system in which a third component is *ortho*- and *peri*-fused to two components that are themselves *ortho*- or *ortho*- and *peri*-fused together. It is important to recall that benzoheterocycles are considered as one component, thus permitting the construction of names that would not otherwise be possible.

Example:

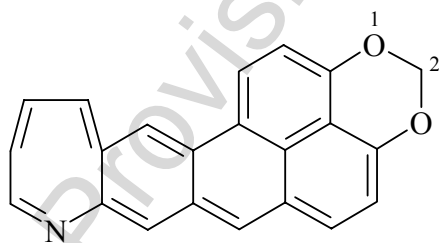

2*H*-[1,3]benzodioxino[6',5',4':10,5,6]anthra[2,3-*b*]azepine (PIN)

(a normal fusion name is not possible when the four components azepine, anthracene, 1,3-dioxine and benzene are treated individually; the use of a benzo name component is necessary; 1-benzazepine cannot be the parent ring because this would require breaking of the attached component having a retained name, anthra, which is not allowed, see P-25.3.5)

When a third component is *ortho*- and *peri*-fused to two components that are themselves *ortho*- or *ortho*- and *peri*-fused together, the following procedures are applied in order until a name can be formed.

P-25.5.1 Skeletal replacement ('a') nomenclature

If the corresponding hydrocarbon fused ring system can be named by fusion principles or has a retained name, then heteroatoms are identified by skeletal replacement ('a') nomenclature using the appropriate 'a' prefixes (see P-22.2.3). The numbering of the fused hydrocarbon system is not altered by the 'a' prefixes.

Examples:

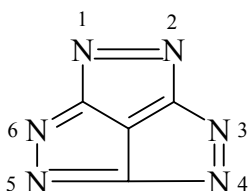

1,2,3,4,5,6-hexaazacyclopenta[*c,d*]pentalene (PIN)

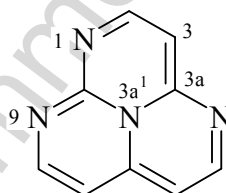

1,3a¹,4,9-tetraazaphenalene (PIN)

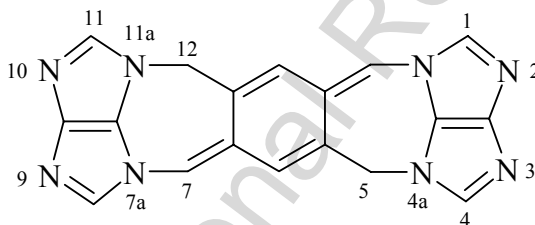

5*H*,12*H*-2,3,4a,7a,9,10,11a,14a-octaazadicyclopenta[*i,j:i'j'*]benzo[1,2-*f*:4,5-*f'*]diazulene (PIN)

P-25.5.2 Selection of a less senior hydrocarbon parent component

A less preferred hydrocarbon parent component is selected that will permit a fusion name. Second and third choice parent components are chosen according to the seniority order for selecting the senior parent component (see P-25.3.2.4).

Examples:

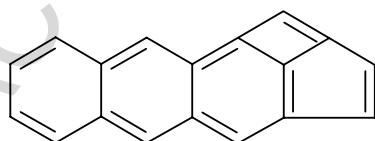

cyclobuta[1,7]indeno[5,6-*b*]naphthalene (PIN)

(anthracene cannot be selected as senior parent component; naphthalene, not indene, is next in seniority order for selection as a parent component)

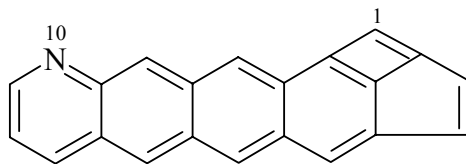

10-azacyclobuta[1,7]indeno[5,6-*b*]anthracene (PIN)

[neither quinoline nor pyridine can be used as the senior parent component because neither naphthalene nor anthracene, respectively, can be used as the senior attached component; therefore 'a' nomenclature must be used (see P.25.5.1) and since the preferred hydrocarbon tetracene cannot be used, the next senior component, anthracene, is chosen as the parent component]

P-25.5.3 Use of bridging nomenclature

A bridged fused system (see Section P-25.4) is used to generate names not possible by using normal fusion nomenclature. A fused system is first envisaged; additional rings are created by using bridges.

Examples:

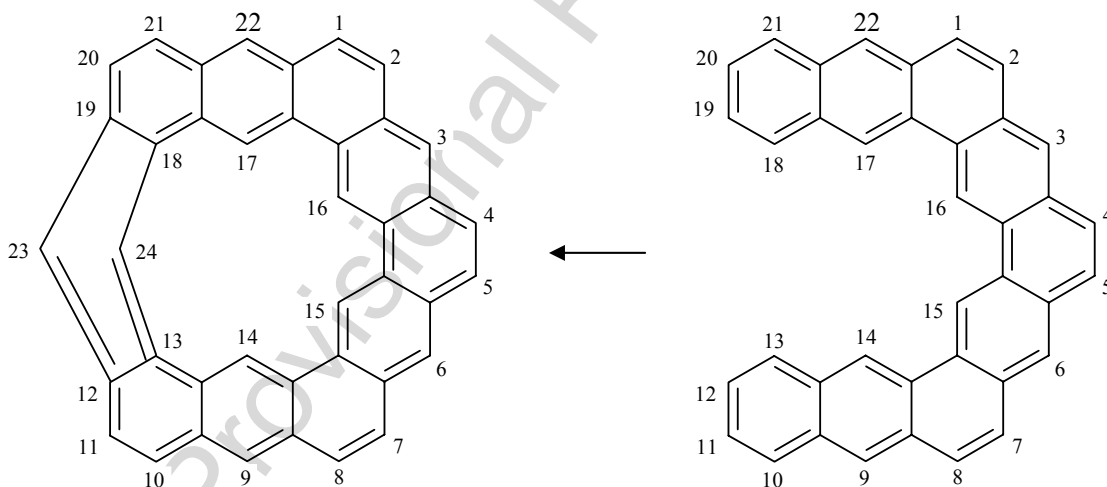

12,19:13,18-dimethenodinaphtho[2,3-*a*: 2'.3'-*o*]pentaphene (PIN)

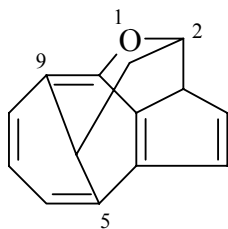

1-oxa-5,9,2-epiethane[1,1,2]triylcycloocta[1,2,3-*cd*]pentalene (PIN)

P-25.6 Fused ring systems with skeletal atoms with nonstandard bonding numbers

The λ -convention is used to describe atoms with nonstandard bonding numbers (ref. 12) in fused ring systems. The symbol λ^n is used, where 'n' is the bonding number of the atoms; it is cited immediately after the locant denoting the atom having the nonstandard bonding number. The symbol *H*, denoting indicated hydrogen atom(s) with the appropriate locant(s), if present, is cited at the front of the complete name.

The λ symbol is used with all rings and ring systems described in this section: monocyclic and polycyclic with retained and fusion names, bi- and polyalicyclic as well as heterocycles formed by 'a' nomenclature, as described above in P-25.5.1. Atoms with nonstandard bonding numbers in fused ring systems are indicated only in the complete ring system, not in component rings. Names and numbering are unchanged, unless a choice must be made between two otherwise equivalent atoms; in which case, low locants are attributed to atoms with the higher bonding numbers, i.e., λ^6 before λ^4 .

Examples:

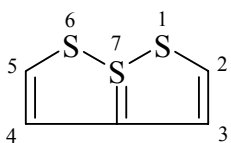

7 λ^4 -[1,2]dithiolo[1,5-*b*][1,2]dithiole (PIN)

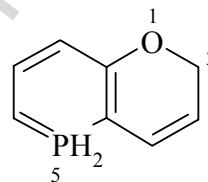

2*H*-5 λ^5 -phosphinino[3,2-*b*]pyran (PIN)

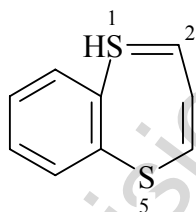

1 λ^4 ,5-benzodithiepine (PIN)

After the maximum number of noncumulative double bonds has been assigned, any ring atom with a bonding order of three or higher connected to adjacent ring atoms by single bonds only, and carrying one or more hydrogen atoms, is designated by the indicated hydrogen symbol *H*. If there is a choice, such ring atoms are selected for low locants.

Example:

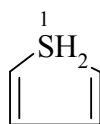

1*H*-1 λ^4 -thiophene (PIN)

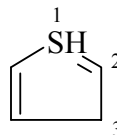

3*H*-1 λ^4 -thiophene (PIN)

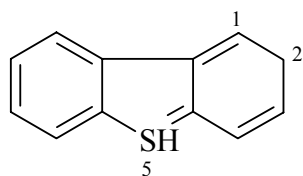

2H-5 λ^4 -dibenzothiophene (PIN)

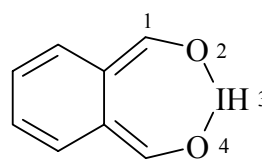

3H-3 λ^3 ,2,4-benziodadioxepine (PIN)

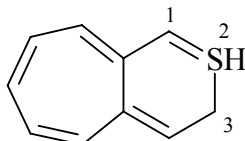

3H-2 λ^4 -cyclohepta[c]thiopyran (PIN)

P-25.7 Double bonds, indicated hydrogen, and the δ -convention

The treatment of double bonds is formalized in fusion nomenclature. A maximum of noncumulative double bonds must be present in fused and bridged fused systems. When hydrogen atoms are in excess at specific positions, they are denoted in names by indicated hydrogen atom(s). To the contrary, the presence of cumulated formal double bonds is also possible. This feature is expressed by the δ -convention (Delta-Convention) (see ref. 18). These two aspects of fused and bridged fused systems are described in this Section.

P-25.7.1 Indicated hydrogen

P-25.7.1.1 Maximum number of non-cumulative double bonds

The names of polycyclic fused ring systems are considered to correspond to the structure with the maximum number of noncumulative double bonds consistent with the appropriate bonding number of the skeletal atoms. To achieve this result, components are fused together and noncumulative double bonds are redistributed in the completed fused system. Hydrogen atoms not attached to atoms connected by double bonds are denoted as indicated hydrogen atom(s).

Examples:

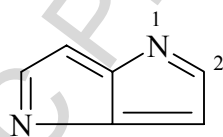

pyrrolo[3,2-*b*]pyrrole (PIN)

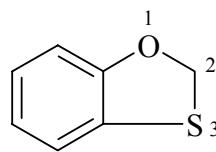

2H-1,3-benzoxathiole (PIN)

If atoms with nonstandard bonding numbers are present, they must be indicated using the λ -convention (and if necessary the δ -convention). The stated bonding number is used in assigning noncumulative double bonds.

Example:

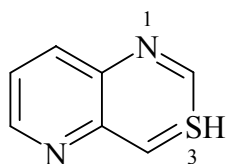

3λ⁴-pyrido[3,2-*d*][1,3]thiazine (PIN)

In bridged fused systems, the distribution of noncumulative double bonds in the parent fused ring system is accomplished after allowance has been made for the bonds existing between the bridge(s) and the fused ring system. Rings that are part of a bridge are treated separately, after consideration of the free valences of the bridge.

Examples:

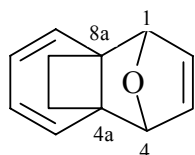

1,4-epoxy-4a,8a-ethanonaphthalene (PIN)

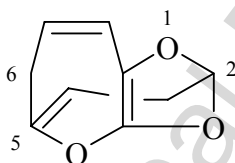

2*H*,6*H*-2,5-(ethanylylidene)[1,3]dioxolo[4,5-*b*]oxepine (PIN)

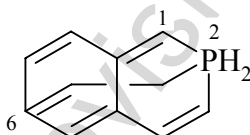

2*H*-2λ⁵-2,6-(ethanylylidene)isophosphinoline (PIN)

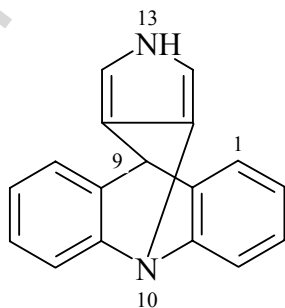

9*H*,13*H*-9,10-[3,4]epipyrroloacridine (PIN)

P-25.7.1.2 Localized double bonds

If it is necessary to identify isomers that differ only by virtue of the location of localized double bonds, this differentiation is indicated by the use of the Greek letter Δ . The locant cited corresponds to the lowest numbered atom of the localized double bond.

Examples:

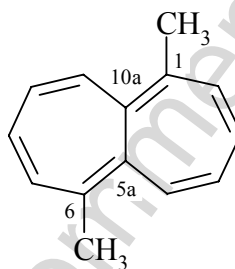
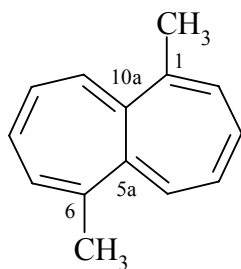

1,6-dimethyl- Δ^1 -heptalene (PIN) 1,6-dimethyl- $\Delta^{1(10a)}$ -heptalene (PIN)

P-25.7.1.3 Citation of indicated hydrogen

When a name applies equally to two or more isomeric systems with the maximum number of non-cumulative double bonds and when the name can be made specific by indicating the position of one or more hydrogen atoms in the structure, this specifically is accomplished by adding to the name the italicized symbol *H* for each of these hydrogen atoms, preceded by the appropriate locant(s).

In general nomenclature, omission of indicated hydrogen atoms is permitted in some parent fused ring systems, when unsubstituted, for example indene rather than *1H*-indene, but *1H*-indene-3-carboxylic acid. Omission of indicated hydrogen is permitted in the following ring systems:

fluorene	<i>9H</i>
indene	<i>1H</i>
phenalene	<i>1H</i>
indazole	<i>1H</i>
indole	<i>1H</i>
isochromene (and chalcogen analogs)	<i>1H</i>
isoindole	<i>2H</i>
perimidine	<i>1H</i>
purine	<i>7H</i>
pyrrole	<i>1H</i>
xanthene	<i>9H</i>

Omission of indicated hydrogen is also permitted in general nomenclature, if no ambiguity would result, for example 1,3-benzodioxole, rather than *2H*-1,3-benzodioxole.

In IUPAC preferred names, however, all indicated hydrogen atoms must be cited when the names are constructed in accordance with the principles of fusion nomenclature.

P-25.7.1.3.1 *ortho*- and *ortho*- and *peri*-fused ring systems

Indicated hydrogen is identified by the locant of the relevant position and cited at the front of the names of the whole ring system, including replacement terms, if any.

Examples:

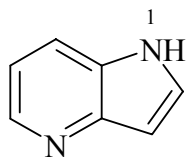

1H-pyrrolo[3,2-*b*]pyridine (PIN)

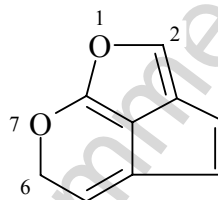

6H-1,7-dioxacyclopenta[*ca*]indene (PIN)

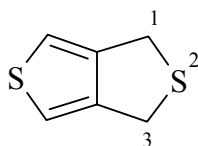

1H,3H-thieno[3,4-*c*]thiophene (PIN)

P-25.7.1.3.2 Bridged fused ring systems

All indicated hydrogen atoms are indicated at the front of the complete name.

This is a change from the previous rule (see Section A-34.4 in ref. 1), which recommended that indicated hydrogen atoms be separated and placed in front of the part (bridge or fused ring system) they qualify.

Examples:

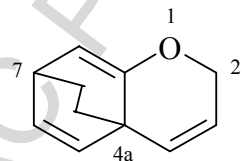

2H,7H-4a,7-ethanochromene (PIN)

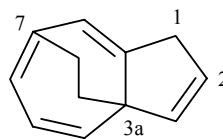

1H-3a,7-ethanoazulene (PIN)

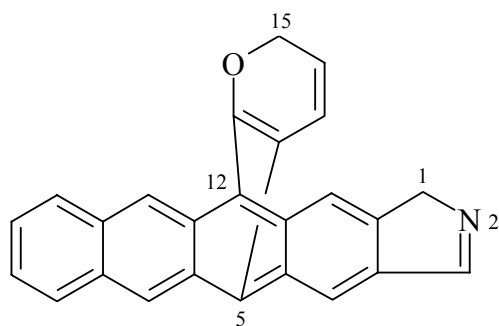

1*H*,15*H*-12,5-[2,3]epipyranoanthra[2,3-*f*]isoindole (PIN)

P-25.7.2 The δ -convention

The presence of contiguous formal double bonds at a skeletal atom in a cyclic parent hydride whose name normally implies the maximum number of noncumulative double bonds is described by the symbol δ^c , where 'c' is the number of double bonds (see ref. 18). The δ^c symbol is cited immediately after an expressed locant for the skeletal atom in the name of the compound and follows the λ^n symbol, if present.

Examples:

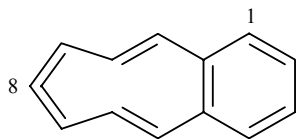

8 δ^2 -benzo[9]annulene (PIN)

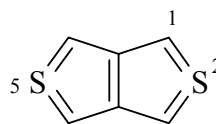

2 $\lambda^4\delta^2$,5 $\lambda^4\delta^2$ -thieno[3,4-*c*]thiophene (PIN)

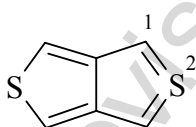

2 $\lambda^4\delta^2$ -thieno[3,4-*c*]thiophene (PIN)

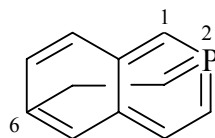

2 $\lambda^5\delta^2$ -6,2-(epiethanylylidene)isophosphinoline (PIN)

P-25.8 Parent compounds in decreasing order of seniority (partial lists)

In this Section rings and ring systems are listed in decreasing order of seniority for selection as a parent component. The first list contains heterocyclic parent components, the second hydrocarbon parent components.

P-25.8.1 Partial list of heterocyclic parent components in decreasing order of seniority

The following list contains parent heterocycles arranged in decreasing order of seniority for selection as the parent component for fusion names. Ring systems containing Hg as given in ref. 4 are not included in these recommendations.

The parent heterocycles are arranged by ring analysis, i.e., in decreasing order of number of rings, ring size, and in accordance with the priority given to heteroatoms, N, O, S, Se, Te, P, etc. and their number; for example phenoxazine (10*H*-isomer shown) is:

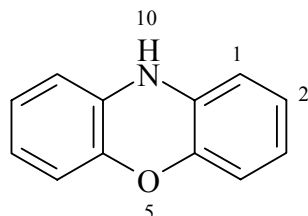

phenoxazine	$C_4NO-C_6-C_6$
phenothiazine	$C_4NS-C_6-C_6$
phenoselenazine	$C_4NSe-C_6-C_6$
phenotellurine	$C_4NTe-C_6-C_6$
phenophosphazinine	$C_4NP-C_6-C_6$
phenarazinine	$C_4NAs-C_6-C_6$
phenazine	$C_4N_2-C_6-C_6$
phenanthroline	$C_5N-C_5N-C_6$ (in accordance with the positions of nitrogen atoms, in decreasing order of seniority: 1,7; 1,8; 1,9; 1,10; 2,7; 2,8; 2,9; 3,7; 3,8;4,7)
perimidine	$C_4N_2-C_6-C_6$
acridine	$C_5N-C_6-C_6$
phenanthridine	$C_5N-C_6-C_6$
carbazole	$C_4N-C_6-C_6$
pteridine	$C_4N_2-C_4N_2$
cinnoline	$C_4N_2-C_6$
quinazoline	$C_4N_2-C_6$
quinoxaline	$C_4N_2-C_6$
1,5-naphthyridine	C_5N-C_5N
1,6-naphthyridine	C_5N-C_5N
1,7-naphthyridine	C_5N-C_5N
1,8-naphthyridine	C_5N-C_5N
phthalazine	$C_4N_2-C_6$
2,6,naphthyridine	C_5N-C_5N
2,7-naphthyridine	C_5N-C_5N
quinoline	C_5N-C_6
isoquinoline	C_5N-C_6
quinolizine	C_5N-C_5N
purine	$C_3N_2-C_4N_2$
indazole	$C_3N_2-C_6$
indole	C_4N-C_6
isoindole	C_4N-C_6
indolizine	C_4N-C_5N
pyrrolizine	C_4N-C_4N

Seven-membered heterocyclic rings or larger with at least one nitrogen atom, e.g., azepine
Six-membered heterocyclic rings with at least three heteroatoms including at least one nitrogen atom, e.g., 1,3,5-oxadiazine

Six-membered heterocyclic rings with at least one nitrogen atom and a different heteroatom, e.g., 1,2-thiazine

pyridazine	C ₄ N ₂
pyrimidine	C ₄ N ₂
pyrazine	C ₄ N ₂
pyridine	C ₅ N

Five-membered heterocyclic rings with at least three heteroatoms, including at least one nitrogen atom, e.g., 1,2,5-oxadiazole (formerly called furazan)

Five-membered heterocyclic rings with one nitrogen atom and a different heteroatom, e.g., 1,2-oxazole

pyrazole	C ₃ N ₂
imidazole	C ₃ N ₂
pyrrole	C ₄ N (the indicated hydrogen may be omitted)

Four- or three-membered heterocyclic rings with at least one nitrogen atom, e.g., azirene

Heterocyclic ring with halogen atom, but no nitrogen atom, e.g., 1λ⁵-1,2-iodoxole

phenoxathiine	C ₄ OS-C ₆ -C ₆
phenoxaselenine	C ₄ OSe-C ₆ -C ₆
phenoxatellurine	C ₄ OTe-C ₆ -C ₆
phenoxaphosphinine	C ₄ OP-C ₆ -C ₆
phenoxarsinine	C ₄ OAs-C ₆ -C ₆
phenoxastibinine	C ₄ OSb-C ₆ -C ₆
oxanthrene	C ₄ O ₂ -C ₆ -C ₆ (formerly called dibenzo[<i>b,e</i>][1,4]dioxine)
xanthene	C ₅ O-C ₆ -C ₆
chromene	C ₅ O-C ₆
isochromene	C ₅ O-C ₆

Seven-membered heterocyclic ring or larger with at least one oxygen atom (no nitrogen atom), e.g., oxepine

Six-membered heterocyclic ring with two or more heteroatoms, at least one of which is oxygen, e.g., 1,4-dioxine

pyran	C ₅ O
-------	------------------

Five-membered heterocyclic ring with two or more heteroatoms, one of which is oxygen (no nitrogen atom), e.g., 1,3-dioxole

furan	C ₄ O
-------	------------------

Four- or three-membered heterocyclic ring with at least one oxygen atom (no nitrogen atom), e.g., oxirene

phenotharsinine	C ₄ SAs-C ₆ -C ₆
thianthrene	C ₄ S ₂ -C ₆ -C ₆
thioxanthene	C ₅ S-C ₆ -C ₆
thiochromene	C ₅ S-C ₆
isothiochromene	C ₅ S-C ₆

Heteromonocyclic ring with at least one sulfur atom (no N nor O atoms). For example:

thiopyran	C ₅ S
thiophene	C ₄ S
selanthrene	C ₄ Se ₂ -C ₆ -C ₆
selenoxanthene	C ₅ Se-C ₆ -C ₆
selenochromene	C ₅ Se-C ₆
isoselenochromene	C ₅ Se-C ₆

Heteromonocyclic ring with at least one selenium atom (no N, O nor S atoms), for example:

selenopyran	C ₅ Se
selenophene	C ₄ Se
telluranthrene	C ₄ Te ₂ -C ₆ -C ₆
telluroxanthene	C ₅ Te-C ₆ -C ₆
tellurochormene	C ₅ Te-C ₆
isotellurochromene	C ₅ Te-C ₆

Heteromonocyclic ring with at least one tellurium atom (no N, O, S, nor Se atoms), for example

telluopyran	C ₅ Te
tellurophene	C ₄ Te
phosphanthrene	C ₄ P ₂ -C ₆ -C ₆
acridophosphine	C ₅ P-C ₆ -C ₆
phosphanthridine	C ₅ P-C ₆ -C ₆
phosphinoline	C ₅ P-C ₆
isophosphinoline	C ₅ P-C ₆
phosphinolizine	C ₅ P-C ₅ P
phosphindole	C ₄ P-C ₆
isophosphindole	C ₄ P-C ₆
phosphindolizine	C ₄ P-C ₄ P

Heteromonocyclic ring with at least one phosphorus atom (no N, O, S, Se, nor Te atoms)

arsanthrene	C ₄ As ₂ -C ₆ -C ₆
acridarsine	C ₅ As-C ₆ -C ₆
arsanthridine	C ₅ As-C ₆ -C ₆
arsinoline	C ₅ As-C ₆
isoarsinoline	C ₅ As-C ₆
arsinolizine	C ₅ As-C ₅ As
arsindole	C ₄ As-C ₆
isoarsindole	C ₄ As-C ₆
arsindolizine	C ₄ As-C ₄ As

Heteromonocyclic ring with at least one arsenic atom, and Sb, Bi, Si, Ge, Sn, Pb, B, Al, Ga, In, and Tl as possible atoms.

silanthrene	C ₄ Si-C ₆ -C ₆
boranthrene	C ₄ B-C ₆ -C ₆

P-25.8.2 Partial list of hydrocarbon parent components in decreasing order of seniority

Parent components are arranged (1) in decreasing order of number of rings; (2) in decreasing order of ring size; (3) in decreasing order of senior orientation; (4) for aceanthrylene and acephenanthrylene, in increasing order of fusion atom locants.

ovalene	$C_6C_6C_6C_6C_6C_6C_6C_6C_6C_6$
octaphenylene	$C_{16}C_6C_6C_6C_6C_6C_6C_6C_6C_6$
tetranaphthylene	$C_8C_6C_6C_6C_6C_6C_6C_6C_6$
nonacene	$C_6C_6C_6C_6C_6C_6C_6C_6C_6$
nonaphene	$C_6C_6C_6C_6C_6C_6C_6C_6C_6$
nonahelicene	$C_6C_6C_6C_6C_6C_6C_6C_6C_6$
octacene	$C_6C_6C_6C_6C_6C_6C_6C_6$
ocataphene	$C_6C_6C_6C_6C_6C_6C_6C_6$
pyranthrene	$C_6C_6C_6C_6C_6C_6C_6C_6$
octahelicene	$C_6C_6C_6C_6C_6C_6C_6C_6$
hexaphenylene	$C_{12}C_6C_6C_6C_6C_6C_6C_6$
heptacene	$C_6C_6C_6C_6C_6C_6C_6C_6$
heptaphene	$C_6C_6C_6C_6C_6C_6C_6C_6$
trinaphthylene	$C_6C_6C_6C_6C_6C_6C_6C_6$
coronene	$C_6C_6C_6C_6C_6C_6C_6C_6$
heptahelicene	$C_6C_6C_6C_6C_6C_6C_6C_6$
rubicene	$C_6C_6C_6C_6C_6C_5C_5$
hexacene	$C_6C_6C_6C_6C_6C_6C_6C_6$
hexaphene	$C_6C_6C_6C_6C_6C_6C_6C_6$
hexahelicene	$C_6C_6C_6C_6C_6C_6C_6C_6$
tetraphenylene	$C_8C_6C_6C_6C_6C_6C_6C_6$
pentacene	$C_6C_6C_6C_6C_6C_6C_6C_6$
pentaphene	$C_6C_6C_6C_6C_6C_6C_6C_6$
perylene	$C_6C_6C_6C_6C_6C_6C_6C_6$
picene	$C_6C_6C_6C_6C_6C_6C_6C_6$
pleiadene	$C_7C_6C_6C_6C_6C_6C_6C_6$
tetracene	$C_6C_6C_6C_6C_6C_6C_6C_6$
tetraphene	$C_6C_6C_6C_6C_6C_6C_6C_6$
chrysene	$C_6C_6C_6C_6C_6C_6C_6C_6$
pyrene	$C_6C_6C_6C_6C_6C_6C_6C_6$
triphenylene	$C_6C_6C_6C_6C_6C_6C_6C_6$
aceanthrylene	$C_6C_6C_6C_5C_5C_5C_5C_5$
acephenanthrylene	$C_6C_6C_6C_5C_5C_5C_5C_5$
fluoranthene	$C_6C_6C_5C_5C_5C_5C_5C_5$
anthracene	$C_6C_6C_6C_6C_6C_6C_6C_6$
phenanthrene	$C_6C_6C_6C_6C_6C_6C_6C_6$
phenalene	$C_6C_6C_6C_6C_6C_6C_6C_6$
fluorene	$C_6C_6C_5C_5C_5C_5C_5C_5$
acenaphthylene	$C_6C_6C_5C_5C_5C_5C_5C_5$
biphenylene	$C_6C_6C_4C_4C_4C_4C_4C_4$

<i>s</i> -indacene	C ₆ C ₅ C ₅
<i>as</i> -indacene	C ₆ C ₅ C ₅
heptalene	C ₇ C ₇
azulene	C ₇ C ₅
naphthalene	C ₆ C ₆
indene	C ₆ C ₅
pentalene	C ₅ C ₅
Monocyclic hydrocarbons	(in decreasing order of size)

IUPAC Provisional Recommendations